



 **Light Efficient Design**

RemPhos

Solera 

 **breezEV**

Light Efficient Design



LEADING THRU INNOVATION



Light Efficient Design





120-277V PART #	347V PART #	REPLACES	WATTAGE	LUMENS	CCT	BASE	DIMENSIONS	LISTINGS
BOLLARD + POST TOP BALLAST BYPASS TYPE B								
LED-8037E345-A		50W	11W	1550/ 1610 /1650	FLEXCOLOR 3000K/ 4000K /5000K	E26	2.6" x 5.3"	cUL US LISTED
LED-8038E345-A	LED-8038E345C-A	70W	14W	1850/ 1950 /1990		E26	2.6" x 5.3"	
LED-8039E345D-A	LED-8039E345C-A	100W	18W	2450/ 2560 /2610		E26	2.6" x 6.3"	cUL US LISTED CLASSIFIED cUL US
LED-8039M345D-A	LED-8039M345C-A					EX39	2.6" x 7.0"	
LED-8029E345-A-FW	LED-8029E345C-A-FW	70W/100W/150W	FLEXWATT 12W/ 18W /24W	1550-3360	FLEXCOLOR 3000K/ 4000K /5000K	E26	3.0" x 6.6"	cUL US LISTED
LED-8029M345-A-FW	LED-8029M345C-A-FW					EX39	3.0" x 6.9"	cUL US LISTED CLASSIFIED cUL US
LED-8024E345-G7-FW	LED-8024E345C-G7-FW	175W/250W/320W	FLEXWATT 35W/ 45W /60W	5140-8870		E26	3.4" x 7.4"	cUL US LISTED
LED-8024M345-G7-FW	LED-8024M345C-G7-FW					EX39	3.4" x 7.8"	cUL US LISTED CLASSIFIED cUL US
LED-8027M345-G7-FW		320W/400W	FLEXWATT 80W/ 100W /110W	11370-15730	EX39	3.8" x 9.5"		
HV LED-8027M345-G7-FW-HV	LED-8027M345-G7-FW-HV							
LED-8075M345-FW		750W	FLEXWATT 150W/ 200W /270W	21700-39000	FLEXCOLOR 3000K/ 4000K /5000K	EX39	5.6" x 12.3"	cUL US LISTED CLASSIFIED cUL US
HV LED-8075M345-FW-HV	LED-8075M345-FW-HV	750W						
MV LED-8000M345-FW-MV	LED-8000M345-FW-MV	1000W	FLEXWATT 300W/ 360W /450W	50100-73300				
HV LED-8000M345-FW-HV		1000W						
LED-8033E30D-G7		175W	35W	5140	3000K	E26	3.4" x 7.2"	cUL US LISTED
LED-8033E40D-G7				5290	4000K			
LED-8033E50D-G7				5360	5000K			
LED-8033M30D-G7				5140	3000K	EX39	3.4" x 7.8"	cUL US LISTED CLASSIFIED cUL US
LED-8033M40D-G7				5290	4000K			
LED-8033M50D-G7				5360	5000K			

DEFAULT WATTAGE AND CCT FOR SUPERFLEX LAMPS ARE SHOWN IN BOLD.

SIZE COMPARISON

SMALLER BECAUSE SIZE DOES MATTER

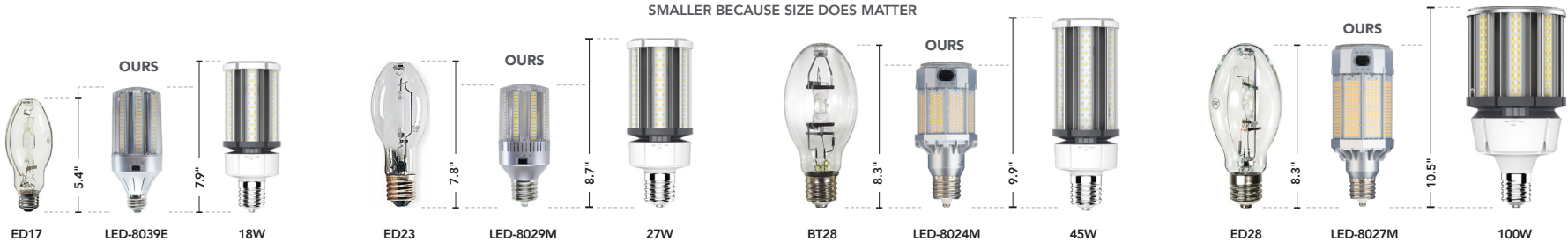

BOLLARD + POST TOP



9 MODELS REPLACING UP TO 1000W HID. Keep the look and feel of your existing fixture, while saving energy and maintenance costs. Several models feature FlexWATT and FlexCOLOR allowing for substantial sku reduction and in-field adjustability.



LED-8038 →



LED-8000 →

LED-8024 →

MULTIPLE VOLTAGE OPTIONS ON 8000 INCLUDING 480V

& LONGER NECK TO BETTER FIT FIXTURES



5 YEAR WARRANTY



BALLAST BYPASS



ACTIVE COOLING*



CRI



ENCLOSED FIXTURES

OPERATING TEMP

-40°F TO 113°F	-40°F TO 122°F
8029 / 8024 / 8027	8037 / 8038 / 8039 8033 / 8000 / 8075

MODELS



DAMP LOCATION ENVIRONMENT



50,000hrs RATED LIFE

* EXCLUDES 8037-39 MODELS.



120-277V PART #	REPLACES	WATTAGE	LUMENS	CCT	BASE	DIMENSIONS	LISTINGS	
BOLLARD + POST TOP BALLAST BYPASS TYPE B								
LED-8015E30-G2	100W INC 70W HID	14W	1792	3000K	E26	2.6" x 5.3"		
LED-8015E40-G2			1918	4000K				
LED-8015E50-G2			1960	5000K				
LED-8017E30-G2-DIM*	150W INC 100W HID	20W	2540	3000K	E26	2.6" x 5.3"		
LED-8017E40-G2-DIM*			2720	4000K				
LED-8017E50-G2-DIM*			2760	5000K				
LED-8017E345-G3	150W INC / 100W HID	20W	2400/ 2700 /2600	FLEXCOLOR 3000K/ 4000K /5000K	E26	2.8" x 5.5"		
LED-8018E345-G3	200W INC / 150W HID	25W	3000/ 3375 /3250			3.4" x 6.8"		
LED-8019E345-G3	300W INC / 175W HID	35W	4200/ 4725 /4550			EX39		3.4" x 7.1"
LED-8019M345-G3	175W HID				EX39	3.9" x 7.9"		
LED-8020M345-G3	250W HID	45W	5400/ 6075 /5850		EX39	4.7" x 9.2"		
LED-8021M345-G3	320W HID	65W	7800/ 8775 /8450		EX39			
LED-8060E22	100W HID	15W	2250	2200K	E26	2.2" x 6.4"		
LED-8060E40			2700	4000K				
LED-8060E50			5000K					
LED-8061E22	150W HID	28W	3500	2200K	E26	3.0" x 7.6"		
LED-8061E40			4000	4000K				
LED-8061E50			5000K					
LED-8062M22	175W HID	32W	4500	2200K	EX39	3.5" x 9.4"		
LED-8062M40			5500	4000K				
LED-8062M50			5000K					
LED-8063M22	250W HID	45W	6000	2200K	EX39	3.5" x 9.4"		
LED-8063M40			7500	4000K				
LED-8063M50			5000K					
LED-8064M22	320W HID	54W	8000	2200K	EX39	4.9" x 9.4"		
LED-8064M40			10000	4000K				
LED-8064M50			5000K					
LED-8065M22	400W HID	85W	13600	2200K	EX39	4.8" x 11.5"		
LED-8065M40			15725	4000K				
LED-8065M50			5000K					

DEFAULT LUMENS AND CCT FOR FLEXCOLOR LAMPS ARE SHOWN IN BOLD.

* LED-8017-G2-DIM IS 120V ONLY. DIMMABLE ON MOST 120V LED RATED DIMMERS, PLEASE SEE WEBSITE FOR LIST OF COMPATIBLE DIMMERS.



BOLLARD + POST TOP



12 MODELS REPLACING UP TO 400W HID. Perfect for post top and bollard fixtures, these retrofits feature frosted lenses (801X + 802X models only) and shapes that closely mimic the outgoing lamp technology. Because of their traditional shapes, several feature Energy Star.



LED-8018 →



FROSTED LENS

← LED-8062



AVAILABLE IN 2200K, 4000K & 5000K



*



BALLAST BYPASS



CRI



ENCLOSED FIXTURES



-40°F TO 113°F

OPERATING TEMP



50,000hrs
RATED LIFE

* ALSO WORKS ON 208V & 240V. LED-8017-G2-DIM IS 120V ONLY.



120-277V PART #	347V PART #	REPLACES	WATTAGE	LUMENS	CCT	BASE	DIMENSIONS	LISTINGS
SHOE BOX + WALL PACK BALLAST BYPASS TYPE B								
LED-8086E30-G4		70W	20W	2800	3000K	E26	2.6" x 5.2"	cUL US LISTED
LED-8086E40-G4				2800	4000K			
LED-8086E50-G4				2880	5000K			
LED-8087E345D-G4	LED-8087E345CD-G4	100W	30W	3500/ 4200 /4300	FLEXCOLOR 3000K/ 4000K /5000K	E26	3.0" x 6.4"	cUL US LISTED
LED-8087M345D-G4	LED-8087M345CD-G4					EX39	3.0" x 6.9"	cUL US LISTED CLASSIFIED US
LED-8088E345D-G4	LED-8088E345CD-G4	175W	50W	6400/ 6900 /7200		E26	3.8" x 7.9"	cUL US LISTED
LED-8088M345D-G4	LED-8088M345CD-G4					EX39	3.8" x 8.5"	cUL US LISTED CLASSIFIED US
LED-8089M345D-G4	LED-8089M345CD-G4	250W	80W	10600/ 10700 /10800			4.3" x 10.0"	
LED-8090M345D-G4		400W	110W	14500/ 15400 /15700			4.3" x 11.4"	
HV LED-8090M345D-G4-HV	LED-8090M345D-G4-HV							
LED-8089M30D-G5		250W	80W	10670	3000K	EX39	4.3" x 8.3"	cUL US LISTED CLASSIFIED US
LED-8089M40D-G5				10760	4000K			
LED-8089M50D-G5				10850	5000K			
LED-8091M40D		1000W	320W	43380	4000K	EX39	9.0" x 12.7" (PANEL) 4.7" x 11.2" (DRIVER)	cUL US LISTED CLASSIFIED US
LED-8091M50D				44610	5000K			
HV LED-8091M40D-HV	LED-8091M40D-HV	1000W	320W	43380	4000K			
HV LED-8091M50D-HV	LED-8091M50D-HV			44610	5000K			

DEFAULT LUMENS AND CCT FOR FLEXCOLOR LAMPS ARE SHOWN IN BOLD.

SIZE COMPARISON

LIGHT DISTRIBUTION / FOOT CANDLE COMPARISON / DLC POLE-MOUNTED FIXTURES

SMALLER BECAUSE SIZE DOES MATTER

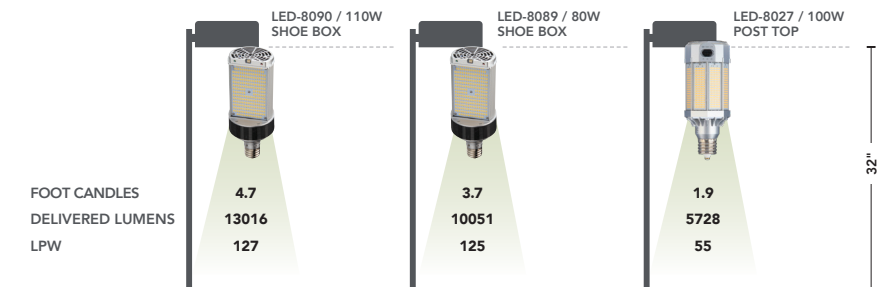
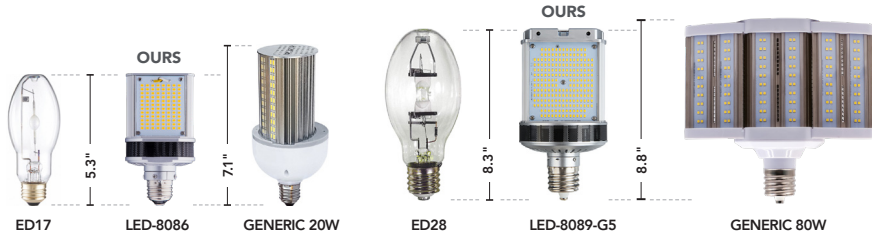

SHOE BOX + WALL PACK



7 MODELS REPLACING UP TO 1000W HID. Retrofit almost any shoe box or wall pack fixture to energy & maintenance saving LEDs. Eliminate ballast failures. FlexCOLOR on several models allows for less stocked inventory as well as field adjustability.



← LED-8091

LED PANEL ADHERES TO FIXTURE LENS



← LED-8088

ROTATABLE BASE – DIRECTS LUMENS OUT OF FIXTURE



120-277V

*



ACTIVE COOLING



CRI



ENCLOSED FIXTURES



-40°F TO 122°F

OPERATING TEMP



DAMP LOCATION ENVIRONMENT



50,000hrs RATED LIFE

* ALSO WORKS ON 208V & 240V.



120-277V PART #	347V PART #	REPLACES	WATTAGE	LUMENS	CCT	BASE	DIMENSIONS	LISTINGS
HIGH BAY BALLAST BYPASS TYPE B								
LED-8136M40D	LED-8136M40CD	250W	90W	12400	4000K	EX39	8.7" x 9.3"	
LED-8136M50D	LED-8136M50CD			12900				
LED-8132M40D	LED-8132M40CD	400W	135W	18600	4000K	EX39	8.7" x 10"	
LED-8132M50D	LED-8132M50CD			19200				
LED-8130M40D	LED-8130M40CD	400W	150W	20900	4000K	EX39	8.7" x 10"	
LED-8130M50D	LED-8130M50CD			21200				
HIGH BAY BALLAST COMPATIBLE TYPE A								
LED-8236M345D	LED-8236M345CD	250W	95W	13700/14400/14600	FLEXCOLOR 3000K/4000K/5000K	EX39	8.7" x 9.7"	
LED-8232M345D		400W	140W	19900/20900/21100		EX39	8.7" x 10.5"	
LED-8232M345D-HV	LED-8232M345D-HV					EX39	10.3" x 12.5"	
LED-8242M40D		1000W	270W	38400	4000K	EX39	10.3" x 12.5"	
LED-8242M50D				38700				
LED-8242M40D-HV	LED-8242M40D-HV			38400	4000K	EX39		
LED-8242M50D-HV	LED-8242M50D-HV			38700	5000K			
HIGH BAY BALLAST COMPATIBLE TYPE A								
LED-8030M40-MHBC		400W	140W	18619	4000K	EX39	9.1" x 9.2"	
LED-8030M57-MHBC				17047				
LOW BAY BALLAST BYPASS TYPE B								
LED-8056E40D-A		175W	45W	5334	4000K	E26	5.7" x 6.9"	
LED-8056E50D-A				5560	5000K			
LED-8056M40D-A				EX39	5334	4000K		
LED-8056M50D-A					5560	5000K		
LED-8035E40-A		175W	60W	6684	4000K	E26	5.7" x 7.4"	
LED-8035E57-A				7062	5700K			

LIGHT DISTRIBUTION / FOOT CANDLE COMPARISON / DLC CEILING-MOUNTED HIGH BAY FIXTURES

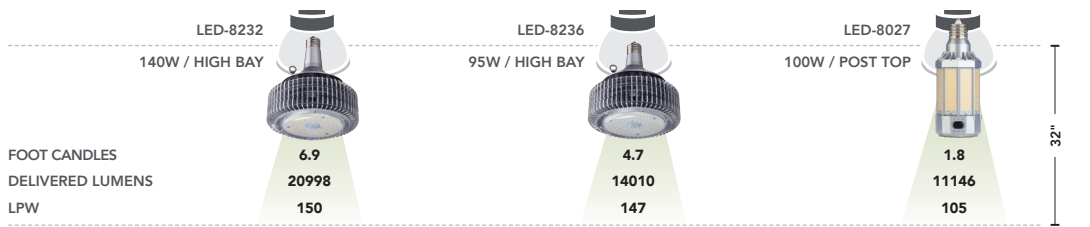

SURGE PROTECTION

HIGH BAY + LOW BAY



9 MODELS REPLACING UP TO 1000W HID. Ultra-bright LED retrofits for high ceiling environments. Models w/o active cooling for open fixtures & silent operation. Models w/ active cooling are safe to install in enclosed fixtures. Low bay retrofits are ideal for ceiling fixtures that require light to be pushed down & out. Angled LED panels help direct light exactly where it is needed.



← LED-8236



LED-8056 →

POWERFUL PERFORMANCE – FOR HIGH BAY ENVIRONMENTS



* EXCLUDES 8030 AND 8035 MODELS. ** EXCLUDES 8100 MODELS.



120-277V PART #	347V PART #	REPLACES	WATTAGE		LUMENS	CCT	BASE	DIMENSIONS	LISTINGS
SOX BALLAST BYPASS TYPE B									
LED-8100-22K		35W	20W		2030	2200K	B22D	12.2" x 2.8"	cUL US
LED-8100-40K					3022	4000K			
LED-8100-AMB*					NA	AMBER			
LED-8101-22K		55W	35W		3232	2200K		16.7" x 2.9"	
LED-8101-40K					5156	4000K			
LED-8101-AMB*					NA	AMBER			
LED-8102-22K		90W	60W		5769	2200K		20.5" x 2.8"	
LED-8102-40K					8198	4000K			
LED-8102-AMB					NA	AMBER			
LED-8104-22K		180W	100W		11576	2200K		43.5" x 2.8"	
LED-8104-40K					11576	4000K			
LED-8104-AMB*					NA	AMBER			

HAZARDOUS LOCATION BALLAST BYPASS TYPE B									
LED-8929E57-HAZ	LED-8929E57C-HAZ	150W	24W		3425	5700K	E26	3.0" x 6.6"	cUL US LISTED
LED-8929M57-HAZ	LED-8929M57C-HAZ						EX39	3.0" x 6.9"	cUL US LISTED CLASSIFIED
LED-8924E50-HAZ	LED-8924E50C-HAZ	250W	49W (347V)	45W (120/277V)	6620	5000K	E26	3.4" x 7.8"	cUL US LISTED
LED-8924M50-HAZ	LED-8924M50C-HAZ		EX39	3.4" x 7.8"			cUL US LISTED CLASSIFIED		

DEFAULT WATTAGE AND CCT FOR SUPERFLEX LAMPS ARE SHOWN IN BOLD.

SURGE ARRESTORS

PART #	DESCRIPTION	ENCLOSURE	NOMINAL DISCHARGE CURRENT	STRIKE RATING	DIMENSIONS
SPD-277P-10KA-EC-1	10kA SURGE ARRESTOR, 120-277V, SERIES W/ THERMAL FUSE	ROUND IP65	10,000A	1@10kA, 2@6.5kA 15@3kA, 110@1.5kA	2.5" x 1.4"
SPD-347P-10KA	10kA SURGE ARRESTOR, 120-347V, SERIES W/ THERMAL FUSE	ROUND IP67			

STEP DOWN TRANSFORMERS

PART #	DESCRIPTION	MAX WATTAGE	VOLTAGE	THD	POWER FACTOR	DIMENSIONS
MTM04506224C-LW	450VA STEP DOWN TRANSFORMER	400W	480/347V IN / 277V OUT	3.4% / 3.8%	0.99	4.2" x 2.7" x 2.2"
MTM01606224C-LW	160VA STEP DOWN TRANSFORMER	140W		4.3% / 4.1%	0.99	4.2" x 2.0" x 1.6"
MTM00506224C-LW	50VA STEP DOWN TRANSFORMER	45W	480/347V IN / 240V OUT	6.2% / 6.7%	0.98 / 0.97	3.0" x 1.7" x 1.4"

SOX + HAZARDOUS LOCATION



THE MOST UNIQUE RETROFITS, BROUGHT TO YOU BY THE LEADER! Hazardous location fixtures are expensive, retrofitting them w/ UL approved lamps is NOT. Two wattages to choose from. SOX retrofits in 4 lengths to adequately fill out the long, narrow fixtures.

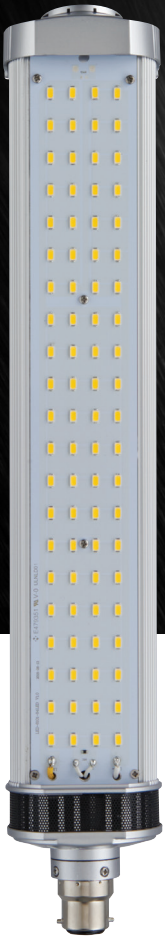

← LED-8101



LED-8924 →

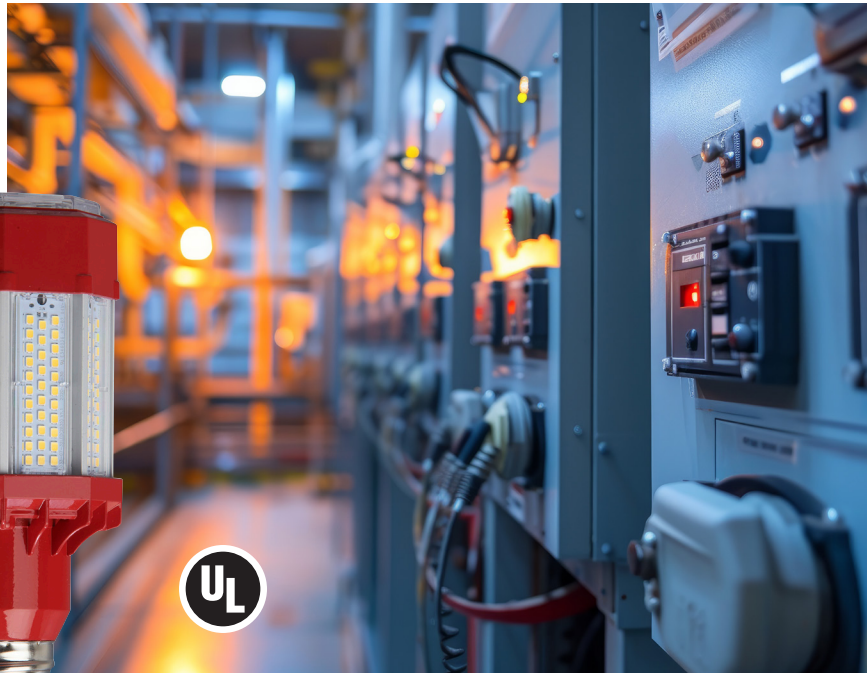
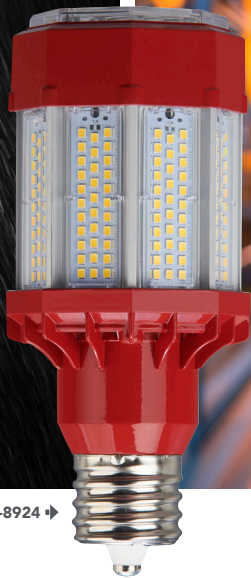

4 LENGTH OPTIONS TO FILL THE ENTIRE FIXTURE

HAZARDOUS LOCATION – CLASS 1 DIV 2



*



BALLAST BYPASS



CRI



ACTIVE COOLING

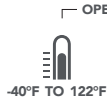

SOX

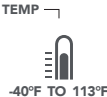

HAZARDOUS



50,000hrs
RATED LIFE

MODELS

* ALSO WORKS ON 208V & 240V.

LIGHT EFFICIENT DESIGN / SCREW-IN RETROFITS



120-277V PART #	REPLACES	WATTAGE	LUMENS	CCT	BEAM ANGLE	BASE	DIMENSIONS	LISTINGS
RECESSED CAN BALLAST BYPASS TYPE B								
LED-8054E27-G2	150W INC 100W HID	30W	2500	2700K	140°	E26	4.2" x 4.8"	
LED-8054E35-G2			3000	3500K				
LED-8054E40-G2			3000	4000K				
LED-8054E50-G2			3000	5000K				
LED-8054E35-G2-DIM*	150W INC 100W HID	30W	3000	3500K		E26		
LED-8054E40-G2-DIM*			3000	4000K				
LED-8054E50-G2-DIM*			3000	5000K				

* LED-8054-G2-DIM ARE 120V ONLY. DIMMABLE ON MOST 120V LED RATED DIMMERS, PLEASE SEE WEBSITE FOR LIST OF COMPATIBLE DIMMERS.



**FANLESS –
FOR SILENT OPERATION**



**EFFICIENT DIE-CAST ALUMINUM
HEAT SINK KEEPS THE FIXTURE COOL**



**RATED FOR DAMP LOCATION
& OPEN FIXTURE**

RECESSED CAN



REPLACING 100W HID. Recessed can fixtures are one of the most common ways to light any commercial space. Our dimmable models will help save even more energy and make interior spaces more appealing.



QUICK & EASY ENERGY SAVINGS

DESIGNED WITH 140° BEAM ANGLE



120-277V

*



BALLAST BYPASS



CRI



OPERATING TEMP
-4°F TO 105°F



50,000hrs
RATED LIFE

* DIMMABLE OPTIONS ARE 120V ONLY.

LIGHT EFFICIENT DESIGN / SCREW-IN RETROFITS



TYPE A + B

FLEXCOLOR

FLEXCOLOR



2-PIN

4-PIN

TYPE A

TYPE B

FLEXCOLOR

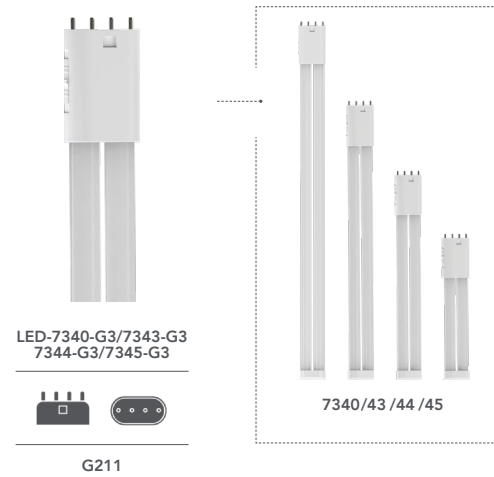

4-PIN

4-PIN



OVER A DOZEN MODELS FOR THE PERFECT SOLUTION. Our latest pin-based LED retrofits now feature FlexCOLOR allowing for substantial sku reduction and in-field adjustability. Perfect for PL applications, and provide a long-lasting LED alternative for areas in offices, hotels, lobbies, schools, etc.



90° ROTATABLE HEAD

LED-7318-FC2

NOW WITH FLEXCOLOR...

& EXTENDED END CAP



*



CRI



7311 / 7312 / 7313
7314 / 7322 / 7324 / 7334



7340 / 7343
7344 / 7345



7316 / 7318 / 7328



7300 / 7310
7320 / 7330

MODELS



50,000hrs
RATED LIFE

* ALSO WORKS ON 208V & 240V.



PART #	REPLACES UP TO	WATTAGE	LUMENS	CCT	BASE	MOUNTING	DIMENSIONS	LISTINGS
PL UNIVERSAL TYPE A+B								
LED-7300-27K-G2	9W / 2-PIN CFL	5W	550	2700K	GX23		5.5" x 1.4"	
LED-7300-35K-G2				3500K				
LED-7300-40K-G2				4000K				
LED-7300-50K-G2				5000K				
LED-7310-FC-G4	26W / 2-PIN CF	9W	1104-1243	FLEXCOLOR 2700/3000K/3500K/4000K	G24d		6.9" x 1.4"	
LED-7313-FC-G4	9W / 2-PIN CFL	3.5W	389-428		G23		5.3" x 1.3"	
LED-7314-FC-G4	13W / 2-PIN CFL	5.5W	628-696		GX23		7.0" x 1.4"	
LED-7311-FC1-G4	26W / 2-PIN CFL	7W	900-950	FLEXCOLOR 3000K/3500K/4000K	G23-2		5.5" x 1.4"	
LED-7312-FC1-G4					GX23-2			
LED-7322-FC1-G4					G24d			
LED-7320-FC1-G4	42W / 4-PIN CFL	10W	1400	FLEXCOLOR 3000K/3500K/4000K	G24q GX24q		6.6" x 1.4"	
LED-7320-FC2-G4				FLEXCOLOR 2700K/4000K/5000K				
LED-7324-FC1-G4	42W / 4-PIN CFL	9W	1400	FLEXCOLOR 3000K/3500K/4000K	G24q GX24q		5.7" x 1.3"	
LED-7324-FC2-G4			1300-1400	FLEXCOLOR 2700K/4000K/5000K				
LED-7316-FC-G2	32W / 2-PIN CFL	9W	1100	FLEXCOLOR 2700/3000K/3500K/4000/5000K	G24d		6.8" x 2.4"	
LED-7318-FC-G2	32W / 4-PIN CFL				G24q			
LED-7328-FC-G2	42W / 4-PIN CFL				G24q			



PART #	REPLACES UP TO	WATTAGE	LUMENS	CCT	BASE	MOUNTING	DIMENSIONS	LISTINGS
--------	----------------	---------	--------	-----	------	----------	------------	----------

PL | BALLAST COMPATIBLE | TYPE A

LED-7330-27K-G2	26W / 4-PIN CFL	10W	760	2700K	G24q GX24q		6.8" x 1.3"	
LED-7330-35K-G2			850	3500K				
LED-7330-40K-G2			916	4000K				
LED-7334-27K-G2	32W / 4-PIN CFL	12W	1100	2700K	G24q GX24q		5.8" x 1.4"	
LED-7334-35K-G2				3500K				
LED-7334-40K-G2				4000K				

PL + PLL | BALLAST BYPASS | TYPE B

LED-7340-FC-G3	40W / 4-PIN CFL	17W	2024-2228	FLEXCOLOR 3000K/3500K/4000K/5000K/6500K	2G11		22" x 1.7"	
LED-7343-FC-G3	36W / 4-PIN CFL	16W	1900-2000				16" x 1.7"	
LED-7344-FC-G3	24W / 4-PIN CFL	10W	1180-1250				12" x 1.7"	
LED-7345-FC-G3	18W / 4-PIN CFL	8.5W	930-980				8.5" x 1.7"	



OPEN FIXTURE ONLY



ENCLOSED FIXTURE RATED (MAY ALSO BE USED IN OPEN FIXTURE)



OMNI-DIRECTIONAL



VERTICAL



HORIZONTAL

LIGHT EFFICIENT DESIGN / PIN-BASE RETROFITS





PART #	REPLACES	WATTAGE	LUMENS	CCT	BASE	DIMENSIONS	LISTINGS
T8 BALLAST COMPATIBLE + BALLAST BYPASS TYPE A+B							
LED-10T8-FCAB24-G4	17W	10W	1450	FLEXCOLOR 3000K/3500K/ 4000K 5000K/6500K	G13	24.0" x 1.0"	
LED-11T8-FCAB36-G4	25W	11W	1650			36.0" x 1.0"	
LED-12T8-FCAB48-G4	32W	12W	1800			48.0" x 1.0"	
LED-15T8-FCAB48-G4		15W	2200				

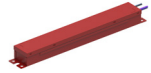

DEFAULT CCT FOR FLEXCOLOR IS SHOWN IN BOLD.





OPTIONAL EMERGENCY BATTERY BACKUP (SOLD SEPARATELY)

T8 BALLAST BYPASS TYPE B							
LED-9T8-840DE24-G3	17W	9W	1150	4000K	G13	24.0" x 1.0"	
LED-12T8-840DE36-G3	25W	12W	1450			36.0" x 1.0"	
LED-12T8-840DE48-G3	32W		1800			48.0" x 1.0"	
LED-42T8-FC-96-G5	86W	42W	5000	FLEXCOLOR 3000K/3500K/ 4000K 5000K/6500K	FA8	93.0" x 1.0"	



T5 | BALLAST COMPATIBLE + BALLAST BYPASS | TYPE A+B

RP-TOTALTUBE-T5-2FT-835-G4	24W	12W	1350	3500K	G5 MINI BI-PIN	24.0" x 1.0"	
RP-TOTALTUBE-T5-2FT-840-G4			1500	4000K			
RP-TOTALTUBE-T5-2FT-850-G4			5000K				
RP-TOTALTUBE-T5-3FT-835-G4	39W	18W	2025	3500K	G5 MINI BI-PIN	36.0" x 1.0"	
RP-TOTALTUBE-T5-3FT-840-G4			2250	4000K			
RP-TOTALTUBE-T5-3FT-850-G4			5000K				
RP-TOTALTUBE-T5-4FT-835-G4	54W	24W	3200	3500K	G5 MINI BI-PIN	48.0" x 1.0"	
RP-TOTALTUBE-T5-4FT-840-G4			3500	4000K			
RP-TOTALTUBE-T5-4FT-850-G4			5000K				



LINEAR T8 + T5 RETROFITS



ENERGY SAVING REPLACEMENTS FOR FLUORESCENT T8, T5 AND U-BEND LAMPS. Every size and installation method you need — in the highest quality, best light output design. Install our retrofits to get worry-free operation for years to come.



◀ LED-10T8-FCA

ENERGY SAVING REPLACEMENTS FOR ANY FACILITY



*



CRI



42T8-FC MODEL

ALL OTHER MODELS

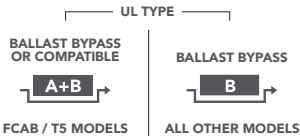

FCAB / T5 MODELS

ALL OTHER MODELS

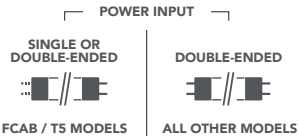

FCAB / T5 MODELS

ALL OTHER MODELS

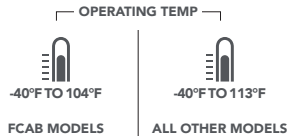

FCAB MODELS

ALL OTHER MODELS



50,000hrs RATED LIFE

* T8 (TYPE B) AND T5 (TYPE A+B) MODELS ALSO WORK ON 208V & 240V.



PART #	VOLTAGE	PWR CORD	DAISY-CHAIN	REPLACES	WATTAGE	LUMENS	CCT	DIMENSIONS	LISTINGS
TEMPORARY WORK SITE LIGHTS									
LED-9006-50K	120V	20 FT POWER CORD	UP TO 10 LIGHTS	250W HID	60W	6600	5000K	6.2" x 10.7"	
LED-9010-50K	120V	35 FT POWER CORD	UP TO 6 LIGHTS	400W HID	100W	11000		6.2" x 12.2"	
LED-9011-50K-G2	120V	35 FT POWER CORD	UP TO 10 LIGHTS						
HIGH BAY WORK SITE LIGHTS BALLAST BYPASS TYPE B									
LED-9210-50K-G2	120-277V*	6 FT POWER CORD W/ STRIPPED LEADS	NA	400W HID	100W	12000	5000K	6.5" x 12.7"	
* UL LISTED FOR 120-277VAC. ALSO WORKS ON 208V & 240V.									
TEMPORARY WORK SITE STRING LIGHTS									
LED-9003-50K-10PK-163-G3	120V	100 FT STRING	UP TO 5 STRINGS	900W INC	120W (10 X 12W)	15000/STRING	5000K	4.4" x 3.1"	
LED-9003-50K-10PK-182-G3			UP TO 4 STRINGS		130W (10 X 13W)	16000/STRING			

WORK LIGHTS



4 MODELS REPLACING UP TO 400W HID. Super bright and durable, our LED work site lights reduce costs and labor with integrated power cord and daisy-chain feature. Several wattages and connection options to choose from will make lighting any work site easier than ever.



◀ LED-9010

35 FT POWER CORD



⬆ LED-9003-182

CONNECT UP TO 4 STRINGS / 400 FT



120-277V



CRI



DAISY-CHAIN

OPERATING TEMP



-40°F TO 104°F

9003



-40°F TO 122°F
9006 / 9010
9011 / 9210

MODELS

INGRESS PROTECTION



IP65
RATED

9003



IP64
RATED

9006 / 9010
9011 / 9210

MODELS



50,000hrs
RATED LIFE

* 9003 MODELS HAVE A 3 YEAR WARRANTY. ** 9210 IS UL LISTED FOR 120-277VAC, 9210 ALSO WORKS ON 208V & 240V. ALL OTHER MODELS ARE 120V. *** EXCLUDES MODEL 9210. LIGHT EFFICIENT DESIGN / WORK LIGHTS

RemPhos

rem·phos /rem·fäs/ *noun*

1. Innovatively engineered LED fixtures and retrofits making installation as fast & easy as possible. **2.** Controllable & customizable LED fixtures and retrofits that maximize the lighting experience for end users. **3.** Brand name derived from a remote layer of phosphor necessary to convert blue LED light to white.



SIMPLE LIGHTING CONTROLS

Looking to add some basic control capability to specific luminaires, and don't need an elaborate networked system? You're in the right place. RemPhos SIMPLE control components are the easiest way to make a luminaire smart.



NETWORKED LIGHTING CONTROLS

Looking to add high value control capabilities at the room, building, or even campus levels? Then you want a RemPhos NETWORKED control system. NETWORKED controls deliver the most control function capabilities and the greatest energy savings.

SILVAIR BLUETOOTH MESH is a leading Networked Lighting Control (NLC) option. The Silvair system and software combine high functionality with ease of use, providing a great overall NLC solution.

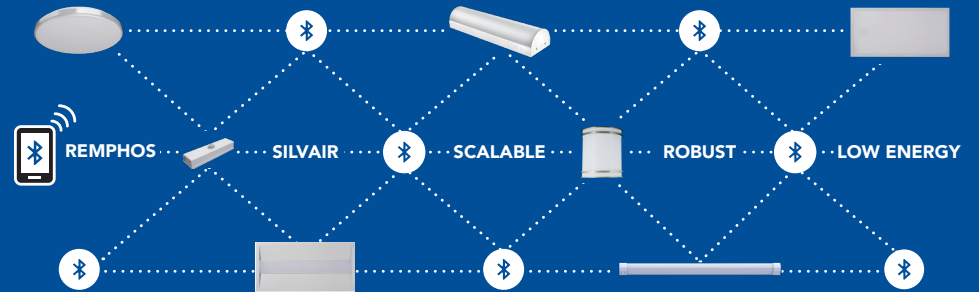

USE THE SILVAIR COMMISSIONING APP TO CONNECT AND CONTROL LIGHTING FIXTURES USING BLUETOOTH MESH TECHNOLOGY. COMPATIBLE WITH IOS AND ANDROID DEVICES, DOWNLOAD ON THE APP STORE OR GOOGLE PLAY.



YOU HAVE A CHOICE BETWEEN SIMPLICITY OR HIGH-CAPABILITY SYSTEMS...



SIMPLE LIGHTING CONTROLS



RP-LBI-OC2-A

IN-LINE MICROWAVE AND DAYLIGHT HARVESTING OCCUPANCY SENSOR



RP-LBI-PIR-A

IN-LINE PASSIVE INFRARED OCCUPANCY SENSOR



NETWORKED LIGHTING CONTROLS



RP-LBI-BLE-A

IN-LINE SILVAIR-READY BLUETOOTH CONTROL NODE



RP-LBI-BLE-PIR-A

IN-LINE SILVAIR-READY BLUETOOTH CONTROL NODE W/ PASSIVE INFRARED OCCUPANCY SENSOR



RP-LBI-BLE-OC

IN-LINE SILVAIR-READY BLUETOOTH MICROWAVE OCCUPANCY SENSOR



*USE THE SILVAIR APP TO ADJUST CONTROL SETTINGS



OPTIONAL REMOTE EMERGENCY BATTERY BACK UP*



REMOTE CONTROL

RP-LBI-EMG2-8W-DIM
(8W / DIMMABLE)

RP-LBI-EMG2-25W-DIM
(25W / DIMMABLE)

RP-LBI-EMG2-25W
(25W / NON DIMMABLE)

RC-REMOTE-IR11
(FOR OCCUPANCY SENSORS)

PART #	WATTAGE	LUMENS	CCT	DIMENSIONS	LISTINGS
LBI – LINKABLE BAR / INTERNAL DRIVER					
RP-LBI-G1-2F-6W-27K-WC2	FLEXWATT 6W/9W/12W	696-1524	FLEXCOLOR 2700K /3000K/3500K	19.3" x 1.2" x 1.2"	
RP-LBI-G1-2F-6W-40K-WC		780-1560	FLEXCOLOR 3000K/4000K /5000K		
RP-LBI-G1-3F-10W-27K-WC2	FLEXWATT 10W/12W/15W	1270-1980	FLEXCOLOR 2700K /3000K/3500K	31.3" x 1.2" x 1.2"	
RP-LBI-G1-3F-10W-40K-WC		1400-2100	FLEXCOLOR 3000K/4000K /5000K		
RP-LBI-G1-4F-15W-27K-WC2	FLEXWATT 10W/15W/25W	1260-3400	FLEXCOLOR 2700K /3000K/3500K	43.3" x 1.2" x 1.2"	
RP-LBI-G1-4F-15W-40K-WC		1462-3653	FLEXCOLOR 3000K/4000K /5000K		

DEFAULT WATTAGE AND CCT ARE SHOWN IN BOLD.



FOR LISTING STATUS GO TO LED-LLC.COM

LINKABLE BAR / INTERNAL DRIVER (LBI)



ONE LIGHT. UNLIMITED POSSIBILITIES...CONNECT UP TO 40 FROM ONE POWER FEED*

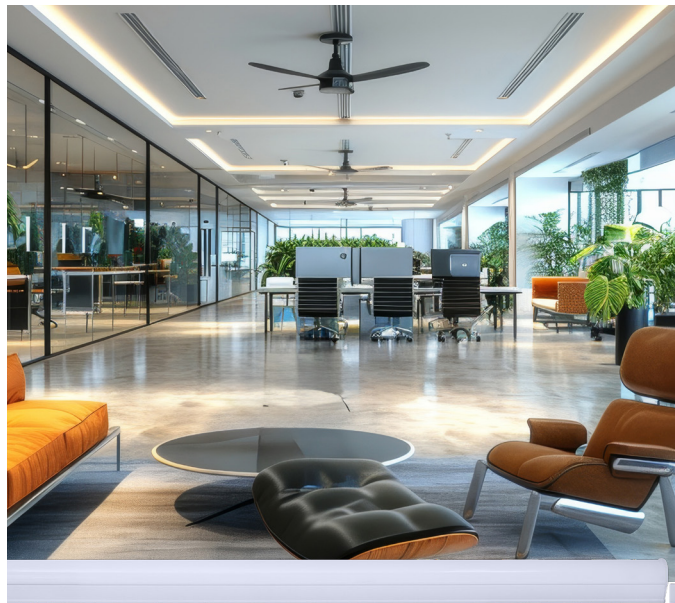

SWITCH BETWEEN WATT & COLOR TEMPS, SO MANY ACCESSORIES...

MOUNTING ACCESSORIES



45° BRACKET



UP DOWN CLIP



SUSPENDED IN-LINE BRACKET KIT

INCOMING POWER

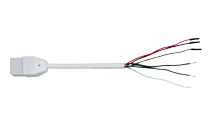

3 FT CABLE KIT



CABLE W/ SWITCH



90° CABLE

CONNECTORS



LINKING CABLE



DIMMABLE



NON-DIMMABLE

... SEAMLESS CONNECTORS ...



SEE SPEC SHEET FOR FULL LINE OF ACCESSORIES



120-277V



0-10V DIM TO OFF



12V AUX OUTPUT



OPTIONAL NETWORK LIGHTING CONTROL



OPTIONAL SIMPLE OCC



OPTIONAL EMG BATTERY BACKUP



EFFICACY (LIGHT ENGINE)



80+



120° BEAM ANGLE



-13°F TO 140°F OPERATING TEMP



PWR FACTOR/THD >0.9 <20% THD



L70 >100,000hrs RATED LIFE**



L90 51,000hrs RATED LIFE

* CONNECT UP TO 33 4FT UNITS TOGETHER @ 120VAC OR 40 4FT UNITS @ 277VAC. ** CALCULATED.



CONTROL CAPABILITIES AT THE ROOM, BUILDING, OR EVEN CAMPUS LEVELS...



SIMPLE LIGHTING CONTROLS



RP-LBI65-PIR-A

IP65 IN-LINE PASSIVE INFRARED OCCUPANCY SENSOR



NETWORKED LIGHTING CONTROLS



RP-LBI65-BLE-A

IP65 IN-LINE SILVAIR-READY BLUETOOTH CONTROL NODE



RP-LBI65-BLE-PIR-A

IP65 IN-LINE SILVAIR-READY BLUETOOTH CONTROL NODE W/ PASSIVE INFRARED OCCUPANCY SENSOR



*USE THE SILVAIR APP TO ADJUST CONTROL SETTINGS



REMOTE CONTROL

WATTAGE & CCT
ADJUSTING REMOTE
INCLUDED W/ EACH LBI65 BAR



OPTIONAL REMOTE EMERGENCY BATTERY BACK UP*



REMOTE CONTROL

RP-LBI-EMG2-8W-DIM
(8W / DIMMABLE)

RP-LBI-EMG2-25W-DIM
(25W / DIMMABLE)

RP-LBI-EMG2-25W
(25W / NON DIMMABLE)

RC-REMOTE-IR11
(FOR PASSIVE INFRARED OCCUPANCY SENSOR)

PART #	WATTAGE	LUMENS	CCT	DIMENSIONS	LISTINGS
LBI 65 – LINKABLE BAR / INTERNAL DRIVER IP65					
RP-LBI65-2F-6W-40K-WC	FLEXWATT 4W/ 6W /9W/12W	640-1920	FLEXCOLOR 2700K, 3000K, 3500K, 4000K , 5000K, 5700K	19.3" x 1.5" x 1.5"	 (PENDING)
RP-LBI65-3F-10W-40K-WC	FLEXWATT 6W/ 10W /12W/15W	960-2400		31.3" x 1.5" x 1.5"	
RP-LBI65-4F-25W-40K-WC	FLEXWATT 10W/15W/20W/ 25W	1920- 4000		43.3" x 1.5" x 1.5"	

DEFAULT WATTAGE AND CCT ARE SHOWN IN BOLD.



FOR LISTING STATUS GO TO LED-LLC.COM

* EMERGENCY BATTERY BACKUP IS FOR INDOOR USE ONLY.

LINKABLE BAR / INTERNAL DRIVER IP65 (LBI65)



WATERPROOF LINKING – NO TOOLS NEEDED...CONNECT UP TO 40 FROM ONE POWER FEED*



SWITCH BETWEEN WATT & COLOR TEMPS, SO MANY ACCESSORIES...

AIRCRAFT SUSPENSION CABLE



10 FT / STAINLESS STEEL + WATERPROOF

INCOMING POWER



3 FT CABLE WIRE WHIP

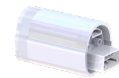

CONDUIT ADAPTER

CONNECTORS

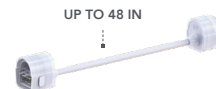

UP TO 48 IN
LINKING CABLE



DIMMABLE W/CCT



NON-DIMMABLE

SEAMLESS CONNECTORS



SEE SPEC SHEET FOR FULL LINE OF ACCESSORIES



120-277V



0-10V DIM TO OFF



12V AUX OUTPUT



OPTIONAL NETWORK LIGHTING CONTROL



OPTIONAL SIMPLE OCC



OPTIONAL EMG BATTERY BACKUP



EFFICACY (LIGHT ENGINE)



CRI



BEAM ANGLE



OPERATING TEMP
-22°F TO 122°F



IK08 IMPACT RESISTANCE



>100,000hrs RATED LIFE (CALCULATED)

* CONNECT UP TO 33 4FT UNITS TOGETHER @ 120VAC OR 40 4FT UNITS @ 277VAC. **PENDING.



THE EASIEST WAY TO MAKE A LUMINAIRE SMART...



SIMPLE LIGHTING CONTROLS



-OCC

MICROWAVE AND DAYLIGHT
HARVESTING
OCCUPANCY SENSOR



NETWORKED LIGHTING CONTROLS



-BT

SILVAIR-READY
BLUETOOTH NODE
W/ EXTERNAL ANTENNA



-OCBT

SILVAIR-READY
BLUETOOTH MICROWAVE
OCCUPANCY SENSOR



*USE THE SILVAIR APP TO ADJUST CONTROL SETTINGS

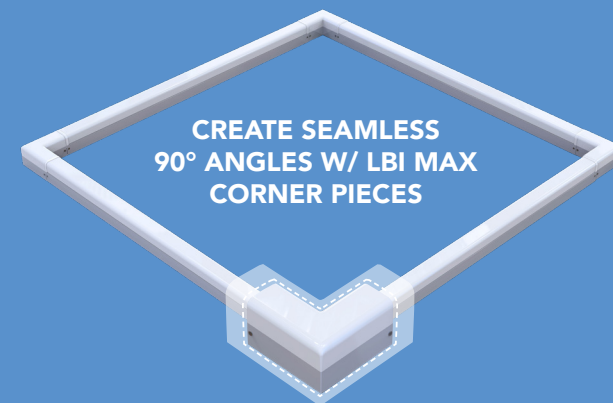

CREATE SEAMLESS
90° ANGLES W/ LBI MAX
CORNER PIECES



OPTIONAL INTERNAL EMERGENCY BATTERY BACK UP

-EM1 / EMERGENCY BATTERY BACKUP (90 MIN / 500 LM)



REMOTE CONTROL

RC-REMOTE-IR12 (FOR MICROWAVE OCC SENSORS)

PART #	WATTAGE	LUMENS	CCT	DIMENSIONS	LISTINGS
LBI MAX – LINKABLE STRIP FIXTURE					
RP-LBIMAX-2F-25W-40K-WC	FLEXWATT / 15W/20W/ 25W /30W	1950-3900	FLEXCOLOR 3000K/3500K/ 4000K /5000K	24" x 2.5" x 3.0"	
RP-LBIMAX-4F-48W-40K-WC	FLEXWATT / 30W/35W/ 40W /48W	3997-6365		48" x 2.5" x 3.0"	
RP-LBIMAX-LR-16W-40K-WC (CORNER RIGHT)	FLEXWATT / 7W/10W/ 13W /16W	910-2080		6" x 2.5" x 3.0"	
RP-LBIMAX-LL-16W-40K-WC (CORNER LEFT)					

DEFAULT WATTAGE AND CCT ARE SHOWN IN BOLD.



FOR LISTING STATUS GO TO LED-LLC.COM

LINKABLE STRIP FIXTURE (LBI MAX)



HIGHER LUMEN – LINKABLE FIXTURE...CONNECT UP TO 40 FROM ONE POWER FEED*

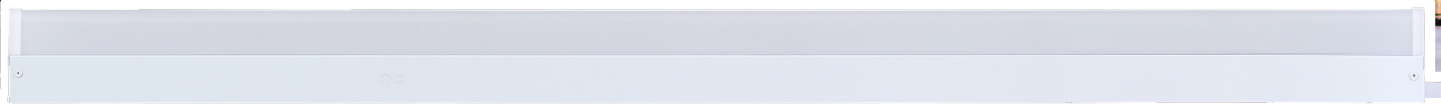

SWITCH BETWEEN WATT & COLOR TEMPS, SO MANY ACCESSORIES...

MOUNTING ACCESSORIES



PENDANT MOUNT KIT



SUSPENSION MOUNT LINKING BRACKET KIT

INCOMING POWER



3 FT CABLE KIT



CABLE W/ SWITCH



90° CABLE

CONNECTORS



LINKING CABLE



DIMMABLE



NON-DIMMABLE

SEAMLESS CONNECTORS



SEE SPEC SHEET FOR FULL LINE OF ACCESSORIES



120-277V



0-10V DIM TO OFF

SENSOR READY



12V AUX OUTPUT



OPTIONAL NETWORK LIGHTING CONTROL



OPTIONAL SIMPLE OCC



OPTIONAL EMG BATTERY BACKUP



EFFICACY (LIGHT ENGINE)



CRI



BEAM ANGLE



-4°F TO 113°F

OPERATING TEMP



>100,000hrs RATED LIFE (CALCULATED)



51,000hrs RATED LIFE

* CONNECT UP TO 20 4 FT UNITS TOGETHER @ 120VAC OR 40 4FT UNITS @ 277VAC.



YOU HAVE A CHOICE BETWEEN SIMPLICITY OR HIGH-CAPABILITY SYSTEMS...

SIMPLE LIGHTING CONTROLS



-OCC

MICROWAVE AND DAYLIGHT
HARVESTING
OCCUPANCY SENSOR

NETWORKED LIGHTING CONTROLS



-BT

SILVAIR-READY
BLUETOOTH NODE
W/ EXTERNAL ANTENNA



-OCBT

SILVAIR-READY
BLUETOOTH MICROWAVE
OCCUPANCY SENSOR



*USE THE SILVAIR APP TO ADJUST CONTROL SETTINGS

EASILY ACCESSORIZE THE LIVC TO FIT YOUR STYLE

OPTIONAL END CAPS

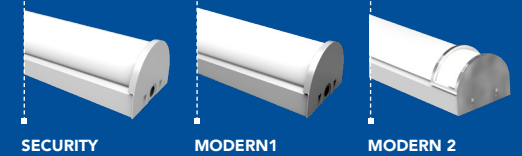



OPTIONAL INTERNAL EMERGENCY BATTERY BACK UP

-EMG / EMERGENCY BATTERY BACKUP (90 MIN / 500 LM)



REMOTE CONTROL

RC-REMOTE-IR12 (FOR MICROWAVE OCC SENSORS)

PART #	WATTAGE	LUMENS	CCT	DIMENSIONS	LISTINGS
LINEAR STRIP					
⊙ RP-B-LS-G2-2FT-25W-40K-WC	FLEXWATT / 10W/15W/ 25W	1950-3250	FLEXCOLOR 3000K/ 4000K /5000K	24.0" x 3.0" x 3.3"	
⊙ RP-B-LS-G2-4FT-30W-40K-WC	FLEXWATT / 25W/ 30W /40W	3250-5200		48.0" x 3.0" x 3.3"	
LIVC – STAIRWELL / VANITY					
RPT-P-LIVC-G2-2FT-20L-840-FWFC-R-S1	FLEXWATT / 10W/ 15W /20W/30W	1240-3750	FLEXCOLOR 3000K/3500K/ 4000K	23" x 6.0" x 4.2"	
RPT-P-LIVC-G2-3FT-20L-840-FWFC-R-S1				34" x 6.0" x 4.2"	
RPT-P-LIVC-G2-4FT-20L-840-FWFC-R-S1				46" x 6.0" x 4.2"	

DEFAULT WATTAGE AND CCT ARE SHOWN IN BOLD.



LINEAR STRIP + STAIRWELL / VANITY (LIVC) |



FROM WIDE FOOTPRINTS TO ULTRA-SLIM, HIGH PERFORMANCE STRIPS...

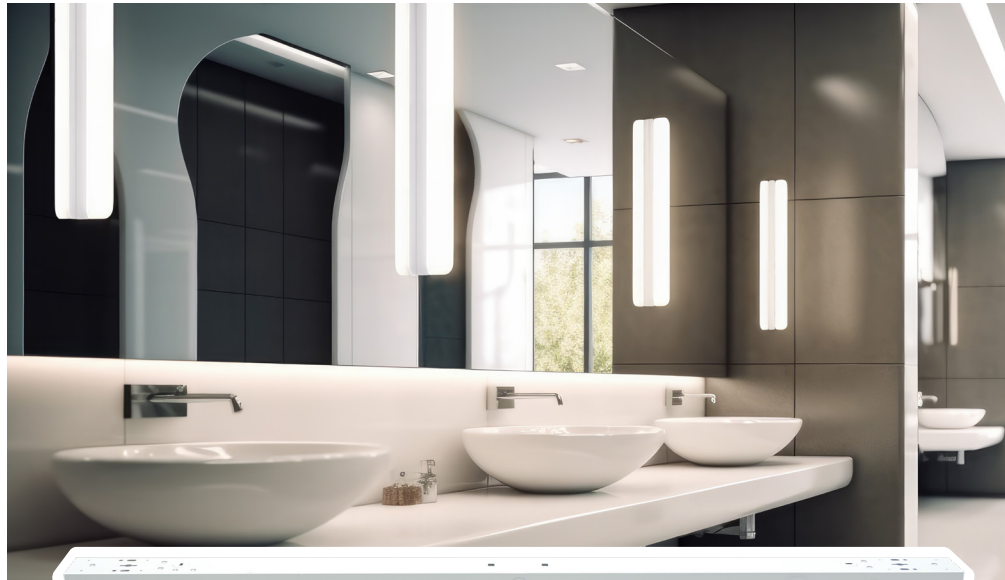

LS-LINEAR STRIP



LIVC



ACCESSORIES (FOR LIVC – STAIRWELL / VANITY)

RPT-P-LIVC-G2-ENDCAP-SECURITY1	2X TAMPER RESISTANT END CAPS
RPT-P-LIVC-G2-ENDCAP-MODERN1	2X SINGLE BAR BRUSHED NICKEL END CAPS
RPT-P-LIVC-G2-ENDCAP-MODERN2	2X DOUBLE BAR BRUSHED NICKEL END CAPS
RPT-P-LIVC-G2-JUNCTION-WHT	JUNCTION BRACKET FOR CONTINUOUS RUNS

ADD A PULL CHAIN FEATURE...



SCAN FOR FULL LINE OF PRODUCT OFFERINGS



120-277V



SENSOR READY



12V AUX OUTPUT



OPTIONAL NETWORK LIGHTING CONTROL



OPTIONAL SIMPLE OCC



OPTIONAL EMG BATTERY BACKUP



EFFICACY



CRI

OPERATING TEMP



-4°F TO 113°F

RP-B-LS



-4°F TO 140°F

RPT-P-LIVC

RATED LIFE



50,000hrs RP-B-LS



100,000hrs RPT-P-LIVC



CONTROL CAPABILITIES AT THE ROOM, BUILDING, OR EVEN CAMPUS LEVELS...



SIMPLE LIGHTING CONTROLS*



-OC1

MICROWAVE AND DAYLIGHT HARVESTING OCCUPANCY SENSOR



-OCLR

LIMITED-RANGE MICROWAVE AND DAYLIGHT HARVESTING OCCUPANCY SENSOR (NO MOUNTING FEET)



NETWORKED LIGHTING CONTROLS*



-BT

SILVAIR-READY BLUETOOTH CONTROL NODE



-OCBT

SILVAIR-READY BLUETOOTH MICROWAVE AND DAYLIGHT HARVESTING OCCUPANCY SENSOR



-BTX

SILVAIR-READY BLUETOOTH CONTROL NODE W/ EXTERNAL ANTENNA



* USE THE SILVAIR APP TO ADJUST CONTROL SETTINGS

OUR DRUM AND SCNCE FIXTURES ARE POWERED BY THE LEDCR/SR ...

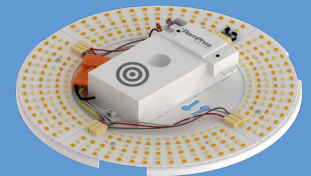

OPTIONAL FIELD INSTALLABLE EMERGENCY BACKUP*

-EMG / EMERGENCY BATTERY BACKUP (90 MIN / 500 LM)



REMOTE CONTROL

RC-REMOTE-IR12 (FOR MICROWAVE OCC SENSORS)

PART #	WATTAGE	LUMENS	CCT	DIMENSIONS	LISTINGS
UTILITY DRUMS					
RP-DRU-11N-14L-40K-WC-G2-A	FLEXWATT / 6W/ 10W /16W/22W	780-3124	FLEXCOLOR / 3000K/3500K/ 4000K	11.0" x 3.5"	
RP-DRU-14N-14L-40K-WC-G2-A				14.0" x 3.5"	
DESIGNER DRUMS					
RP-DRD-14N-14L-40K-WC-G2-A	FLEXWATT / 6W/ 10W /16W/22W	780-3124	FLEXCOLOR / 3000K/3500K/ 4000K	14.5" x 3.5"	
RP-DRD-18N-14L-40K-WC-G2-A				18.0" x 3.5"	
OUTDOOR DRUM					
RP-DRO-12N-14L-40K-WC-G2	FLEXWATT / 6W/ 10W /16W/22W	780-3124	FLEXCOLOR / 3000K/3500K/ 4000K	12.0" x 4.0"	
TOUGH DRUM					
RP-DRT-13N-14L-40K-WC-G2	FLEXWATT / 6W/ 10W /16W/22W	780-3124	FLEXCOLOR / 3000K/3500K/ 4000K	13.0" x 3.8"	

DEFAULT WATTAGE AND CCT ARE SHOWN IN BOLD.



FOR LISTING STATUS GO TO LED-LLC.COM

* EMERGENCY BATTERY BACKUP IS NOT COMPATIBLE WITH TOUGH DRUM (DRT).



DRUM AND SCONCE FIXTURES IN SEVERAL SIZES & DESIGNS...



← RP-SCD-SCONCE



↗ RP-DRD DESIGNER DRUM



PART #	WATTAGE	LUMENS	CCT	DIMENSIONS	LISTINGS
	SCONCE				
RP-SCD-11N-8L-40K-WC-G2	FLEXWATT 6W/10W/12W/15W	780-3125	FLEXCOLOR 3000K/3500K/4000K	13.0" x 3.8"	



SCAN FOR FULL LINE OF PRODUCT OFFERINGS

- 120-277V
*
- 0-10V
DIM TO OFF
SENSOR READY
- 12V
AUX OUTPUT
- OPTIONAL NETWORK LIGHTING CONTROL
- OPTIONAL SIMPLE OCC
- OPTIONAL EMG BATTERY BACKUP
- 120°
BEAM ANGLE
- 80+
CRI
- 4°F TO 140°F
OPERATING TEMP
- 100,000hrs
RATED LIFE

* ALSO WORKS ON 208V & 240V.



THE EASIEST WAY TO MAKE A LUMINAIRE SMART...



SIMPLE LIGHTING CONTROLS*



-OCC

MICROWAVE AND DAYLIGHT HARVESTING OCCUPANCY SENSOR



-OCLR

LIMITED-RANGE MICROWAVE AND DAYLIGHT HARVESTING OCCUPANCY SENSOR (NO MOUNTING FEET)



NETWORKED LIGHTING CONTROLS*



-BT

SILVAIR-READY BLUETOOTH CONTROL NODE



-OCBT

SILVAIR-READY BLUETOOTH MICROWAVE AND DAYLIGHT HARVESTING OCCUPANCY SENSOR



-BTX

SILVAIR-READY BLUETOOTH CONTROL NODE W/ EXTERNAL ANTENNA



* USE THE SILVAIR APP TO ADJUST CONTROL SETTINGS

EXPANDABLE LED PANELS...

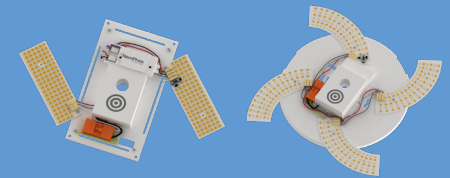

(LEDSR-4IN + LEDCR-9IN ONLY)



OPTIONAL FIELD INSTALLABLE EMERGENCY BACKUP (SHIPS SEPARATELY)

-EMG / EMERGENCY BATTERY BACKUP (90 MIN / 500 LM)



REMOTE CONTROL

RC-REMOTE-IR12 (FOR MICROWAVE OCC SENSORS)

PART #	WATTAGE	LUMENS	CCT	DIMENSIONS	LISTINGS
LEDCR – CIRCULAR RETROFIT KIT					
RPT-P-LEDCR-G2-9IN-14L-840-FWFC	FLEXWATT 6W/10W/16W/22W	780-3124	FLEXCOLOR 3000K/3500K/4000K	8.7" x 8.7" x 2.0"	
LEDSR – SCONCE RETROFIT KITS					
RPT-P-LEDSR-G2-4IN-8L-840-FWFC	FLEXWATT 6W/10W/12W/15W	780-2130	FLEXCOLOR 3000K/3500K/4000K	6.5" x 7.0" x 2.1"	
RPT-P-LEDSR-G2-9IN-8L-840-FWFC				8.7" x 4.5" x 2.0"	
RPT-P-LEDSR-G2-14INE-8L-840-FWFC				14.0" x 2.7" x 2.1"	
RPT-P-LEDSR-G2-14INM-8L-840-FWFC					

DEFAULT WATTAGE AND CCT ARE SHOWN IN BOLD.



FOR LISTING STATUS GO TO LED-LLC.COM

WALL + CEILING



KEEP YOUR EXISTING FIXTURE AND FUTURE-PROOF IT...



LEDSR-4IN

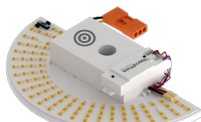

LEDSR-9IN

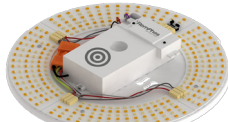

LEDCR-G2-9IN

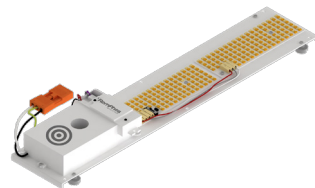

LEDSR-14IN-NE

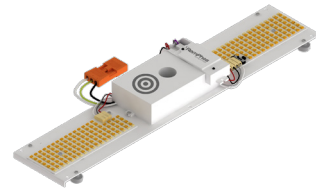

LEDSR-14IN-NM



*



SENSOR READY



12V AUX OUTPUT



OPTIONAL NETWORK LIGHTING CONTROL



OPTIONAL SIMPLE OCC



BEAM ANGLE



OPTIONAL EMG BATTERY BACKUP



80+

CRI



-4°F TO 140°F
OPERATING TEMP



100,000hrs
RATED LIFE

* ALSO WORKS ON 208V & 240V.



YOU HAVE A CHOICE BETWEEN SIMPLICITY OR HIGH-CAPABILITY SYSTEMS...



SIMPLE LIGHTING CONTROLS



RC-OCC-HNS-111-A

MICROWAVE AND DAYLIGHT HARVESTING OCCUPANCY SENSOR



RC-OCLR-HNS111LR-A

LIMITED-RANGE MICROWAVE AND DAYLIGHT HARVESTING OCCUPANCY SENSOR (NO MOUNTING FEET)



NETWORKED LIGHTING CONTROLS*



RC-BT-HNB131CTL

SILVAIR-READY BLUETOOTH CONTROL NODE



RC-BTX-HNB136

SILVAIR-READY BLUETOOTH NODE W/ EXTERNAL ANTENNA



RC-OCBT-HNB115MW

SILVAIR-READY BLUETOOTH MICROWAVE AND DAYLIGHT HARVESTING OCCUPANCY SENSOR



*USE THE SILVAIR APP TO ADJUST CONTROL SETTINGS



OPTIONAL EMG / STAND-ALONE BATTERY BACKUP (SHIPS SEPARATELY)

RP-EM-SK1-500LM/90-3x1.5
90 MINUTE EMG W/ 3 IN X 1.5 IN LED MODULE

RP-EM-SK1-500LM/90-4.7x0.8
90 MINUTE EMG W/ 4.7 IN X 0.8 IN LED MODULE

RP-EM-SK1-500LM/90-1FT
90 MINUTE EMG W/ 10.2 IN X 0.9 IN LED MODULE



120-277V | 120-347V
*



0-10V
DIM TO OFF
SENSOR READY



12V
AUX OUTPUT



OPTIONAL NETWORK LIGHTING CONTROL



OPTIONAL SIMPLE OCC



OPTIONAL EMG BATTERY BACKUP



1167 LPW
EFFICACY (LIGHT ENGINE)



120°
BEAM ANGLE



80+
CRI



-4°F TO 122°F
OPERATING TEMP



100,000hrs
RATED LIFE

LINEAR BARKITS / EXTERNAL DRIVER (LBE) + TYPE C T5 & T8 KITS



TRADITIONAL LOOK OF FLUORESCENT TUBES OR HIGHER EFFICIENCY OF A BARKIT...

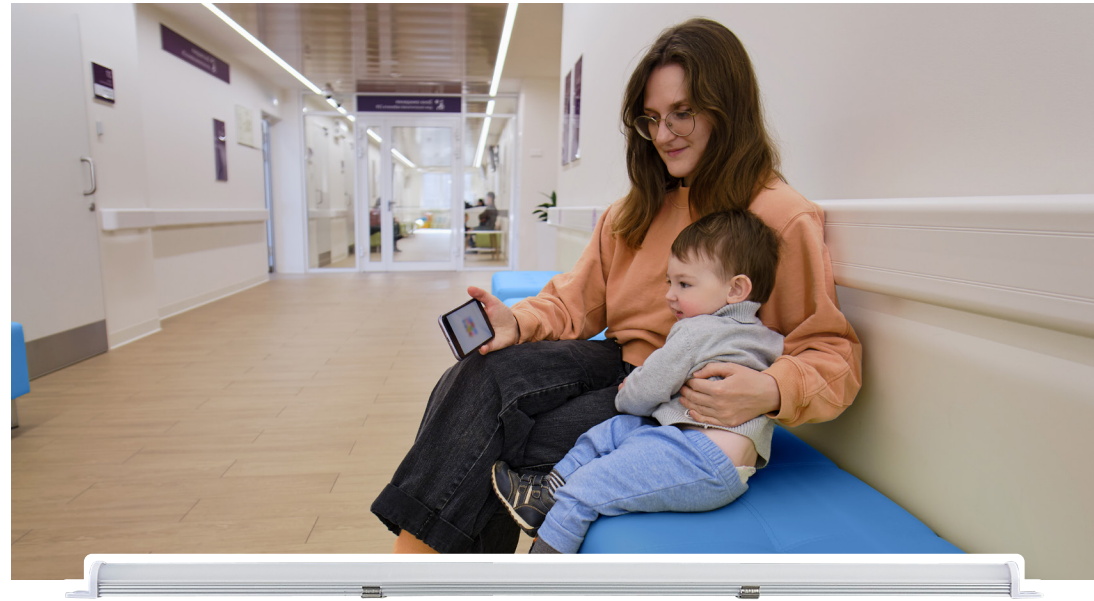

BUILD YOUR TYPE C T5 & T8 KITS				BUILD YOUR LBE			
RP-T5C-G2-[WATTAGE]-[LENGTH]-[#LAMPS]-[8+COLOR]-[DIMMING]-[HV*] RP-T8C-G2-[WATTAGE]-[LENGTH]-[#LAMPS]-[8+COLOR]-[DIMMING]-[HV*]				RP-LBE-G2-[WATTAGE]-[LENGTH]-[#LAMPS]-[8+COLOR]-[DIMMING]-[HV*]			
WATTAGE							
12W (6-8-10-12)		25W (15-18-20-25)		45W (30-35-40-45)		80W (50-60-70-80)	
TYPE C LENGTH				LBE LENGTH			
2 FT		3 FT		4 FT		1 FT	
2 FT		3 FT		4 FT		2 FT	
2 FT		3 FT		4 FT		3 FT	
2 FT		3 FT		4 FT		4 FT	
# OF LAMPS				COLOR			
1L 1 LAMP	2L 2 LAMPS	3L 3 LAMPS	4L 4 LAMPS	30 (3000K)	35 (3500K)	40 (4000K)	50 (5000K)
STANDARD DIMMING				OPTIONAL DIMMING			
10V 0-10V DIM				LVD 120-277V TRIAC			
1 STEP SINGLE SWITCH				2 STEP 2 SWITCH			

* ADD - HV WHEN ORDERING HIGH VOLTAGE (120-347V).



CONTROL CAPABILITIES AT THE ROOM, BUILDING, OR EVEN CAMPUS LEVELS...



SIMPLE LIGHTING CONTROLS



-OCC

MICROWAVE AND DAYLIGHT HARVESTING OCCUPANCY SENSOR



-OCLR

LIMITED-RANGE MICROWAVE AND DAYLIGHT HARVESTING OCCUPANCY SENSOR (NO MOUNTING FEET)



NETWORKED LIGHTING CONTROLS*



-BT

SILVAIR-READY BLUETOOTH CONTROL NODE



-OCBT

SILVAIR-READY BLUETOOTH MICROWAVE AND DAYLIGHT HARVESTING OCCUPANCY SENSOR



-ARM-OCGBT-BTX

SILVAIR-READY BLUETOOTH PASSIVE INFRARED EXTERNAL ARM SENSOR



*USE THE SILVAIR APP TO ADJUST CONTROL SETTINGS

TAA

THESE PRODUCTS MEET THE REQUIREMENTS OF THE UNITED STATES TRADE AGREEMENTS ACT (TAA)



OPTIONAL FIELD INSTALLABLE EMERGENCY BACK UP (SHIPS SEPARATELY)

EMG ADDERS / 4W / 500LM @ 90 MIN / 5000K

EMG ADDERS / 8W / 1000LM @ 90 MIN / 5000K

EMG ADDERS / 4W / 500LM @ 90 MIN / 5000K		EMG ADDERS / 8W / 1000LM @ 90 MIN / 5000K		
-EM1 4.7 IN X 8 IN LED MODULE	-EM2 3 IN X 8 IN LED MODULE	-EM4 1 FT LED MODULE	-EM8 1 FT LED MODULE	-EM9 4.7 IN X 8 IN LED MODULE



FOR LISTING STATUS GO TO LED-LLC.COM

* ORDER AS -HV

TAA LINEAR BARKITS / EXTERNAL DRIVER (LBE) + TYPE C T5 & T8 KITS



SOLUTIONS THAT MEET THE REQUIREMENTS OF THE UNITED STATES TRADE AGREEMENT ACT...



BUILD YOUR TAA LBE				BUILD YOUR TAA TYPE C T5 & T8 KITS			
RP-LBE-G2-[WATTAGE]-[FT]-[#LAMPS]-[8+COLOR]-[DIMMING]-[CONTROLS]-[EM#]-[TAA]				RP-T5C-G2-[WATTAGE]-[FT]-[#LAMPS]-[8+COLOR]-[DIMMING]-[CONTROLS]-[EM#]-[TAA] RP-T8C-G2-[WATTAGE]-[FT]-[#LAMPS]-[8+COLOR]-[DIMMING]-[CONTROLS]-[EM#]-[TAA]			
12W (6-8-10-12)		25W (15-18-20-25)		45W (30-35-40-45)		80W (50-60-70-80)	
CHOOSE YOUR LBE LENGTH				CHOOSE YOUR TYPE C LENGTH			
2 FT		3 FT		2 FT		3 FT	
4 FT				4 FT			
# OF LAMPS				COLOR			
1L 1 LAMP	2L 2 LAMPS	3L 3 LAMPS	4L 4 LAMPS	30 (3000K)	35 (3500K)	40 (4000K)	50 (5000K)
				STANDARD DIMMING		OPTIONAL DIMMING	
				10V 0-10V DIM		LVD 120-277V TRIAC	
						1 STEP SINGLE SWITCH	
						2 STEP 2 SWITCH	
OPTIONAL FIELD INSTALLABLE EMERGENCY BACK UP (SEE PG 18)							

* ADD - HV WHEN ORDERING HIGH VOLTAGE (120-347V).



THE EASIEST WAY TO MAKE A LUMINAIRE SMART...

SIMPLE LIGHTING CONTROLS



-OCC

PASSIVE INFRARED
AND DAYLIGHT HARVESTING
OCCUPANCY SENSOR

NETWORKED LIGHTING CONTROLS



-BT

SILVAIR-READY
BLUETOOTH
CONTROL NODE



-OCCBT

SILVAIR-READY
PASSIVE INFRARED AND
DAYLIGHT HARVESTING
OCCUPANCY SENSOR



*USE THE SILVAIR APP TO ADJUST CONTROL SETTINGS

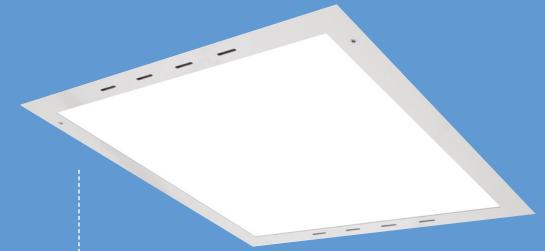

NEED AIR RETURN...
ADD -AIR TO PART NUMBER
WHEN ORDERING



OPTIONAL INTERNAL EMERGENCY BATTERY BACK UP

-EMG / EMERGENCY BATTERY BACKUP (90 MIN / 500 LM)



REMOTE CONTROL

RC-REMOTE-IR12 (FOR MICROWAVE OCC SENSORS)

PART #	WATTAGE	LUMENS	CCT	DIMENSIONS	LISTINGS
TROFFER RETROFIT KITS & FIXTURES					
RP-TTV-G1-2X2-20L-840-FWFC-SR	FLEX WATT / 16W/20W/24W/28W	2000-3640	FLEX COLOR 3500K/4000K/5000K	23.7" x 23.7" x 1.6"	
RP-TTV-G1-1X4-25L-840-FWFC-SR	FLEX WATT / 16W/20W/24W/28W	1968-3556		11.9" x 47.8" x 1.5"	
RP-TTV-G1-2X4-33L-840-FWFC-SR	FLEX WATT / 20W/26W/34W/40W	2540-5300		23.7" x 47.8" x 1.6"	
RP-TTF-G1-2X2-20L-840-FWFC-SR	FLEX WATT / 16W/20W/24W/28W	2000-3640		23.7" x 23.7" x 1.7"	
RP-TTF-G1-1X4-25L-840-FWFC-SR	FLEX WATT / 16W/20W/24W/28W	1968-3556		11.9" x 47.8" x 1.7"	
RP-TTF-G1-2X4-33L-840-FWFC-SR	FLEX WATT / 20W/26W/34W/40W	2540-5300		23.7" x 47.8" x 1.7"	

DEFAULT WATTAGE AND CCT ARE SHOWN IN BOLD.



FOR LISTING STATUS GO TO LED-LLC.COM

TROFFER RETROFIT KITS & FIXTURES



USE AS A RETROFIT KIT OR A FIXTURE – ONE PIECE DESIGN – 2X FASTER INSTALL...



ACCESSORIES

PART #	DESCRIPTION	PART #	DESCRIPTION
RPT-LEDPANEL-SMK-2X2	2X2 SURFACE MOUNT KIT	RPT-LEDPANEL-FMK-2X2-A	2X2 FLANGE KIT
RPT-LEDPANEL-SMK-1X4*	1X4 SURFACE MOUNT KIT	RPT-LEDPANEL-FMK-1X4-A	1X4 FLANGE KIT
RPT-LEDPANEL-SMK-2X4	2X4 SURFACE MOUNT KIT	RPT-LEDPANEL-FMK-2X4-A	2X4 FLANGE KIT

* NOT COMPATIBLE W/ 1X4 TTF

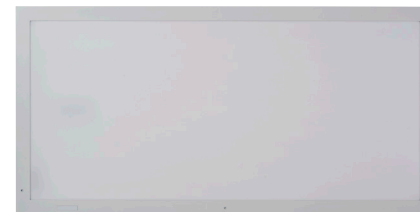

RP-TTF (FLAT PANEL)

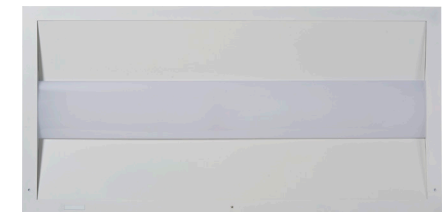

RP-TTV (VOLUMETRIC)

- 120-277V
- 0-10V
DIM TO OFF
- 12V
AUX OUTPUT
- OPTIONAL NETWORK
LIGHTING CONTROL
- OPTIONAL
SIMPLE OCC
- OPTIONAL EMG
BATTERY BACKUP
- EFFICACY
- 80+
- 110°
BEAM ANGLE
- OPERATING TEMP
- 6kA
SURGE
PROTECTION
- 100,000hrs
RATED LIFE

* ALSO WORKS ON 208V & 240V.

REMPHOS / FIXTURES + RETROFIT KITS



YOU HAVE A CHOICE BETWEEN SIMPLICITY OR HIGH-CAPABILITY SYSTEMS...



SIMPLE LIGHTING CONTROLS



-OCC

PASSIVE INFRARED AND DAYLIGHT HARVESTING OCCUPANCY SENSOR



NETWORKED LIGHTING CONTROLS



-OCCBT

SILVAIR-READY PASSIVE INFRARED AND DAYLIGHT HARVESTING OCCUPANCY SENSOR



*USE THE SILVAIR APP TO ADJUST CONTROL SETTINGS

COMING SOON...





OPTIONAL INTERNAL EMERGENCY BATTERY BACK UP

-EMG1 / EMERGENCY BATTERY BACKUP (90 MIN / 500 LM)



REMOTE CONTROL

RC-REMOTE-IR12 (FOR MICROWAVE OCC SENSORS)

PART #	WATTAGE	LUMENS	COLOR	DIMENSIONS	LISTINGS
TROFFER FIXTURES					
RP-TV-G1-1X4-35W-40K-WC-TAA	FLEXWATT / 18W/26W/ 35W	2200/3300/ 4400	FLEXCOLOR 3500K/ 4000K /5000K	11.9" x 47.8" x 1.4"	  
RP-TV-G1-2X2-35W-40K-WC-TAA				23.7" x 23.7" x 1.4"	
RP-TV-G1-2X4-44W-40K-WC-TAA	FLEXWATT / 26W/35W/ 44W	3300/4400/ 5500		23.7" x 47.8" x 1.4"	
RP-TF-G1-1X4-40W-40K-WC-TAA	FLEXWATT / 20W/30W/ 40W	2600/3900/ 5200		11.9" x 47.8" x 1.4"	
RP-TF-G1-2X2-40W-40K-WC-TAA				23.7" x 23.7" x 1.4"	
RP-TF-G1-2X4-50W-40K-WC-TAA				FLEXWATT / 30W/40W/ 50W	

DEFAULT WATTAGE, LUMENS AND CCT ARE SHOWN IN BOLD.



 FOR LISTING STATUS GO TO LED-LLC.COM

TAA TROFFER RETROFIT KITS (TRV/TRF) & FIXTURES (TV/TF)



SOLUTIONS THAT MEET THE REQUIREMENTS OF THE UNITED STATES TRADE AGREEMENT ACT...



RP-TRV (VOLUMETRIC)



RP-TRF (FLAT PANEL)



PART #	WATTAGE	LUMENS	COLOR	DIMENSIONS	LISTINGS
TROFFER RETROFIT KITS					
RP-TRV-2X2-24W-40K-WC-TAA	FLEXWATT / 16W/20W/ 24W	2000/2500/ 3000	FLEXCOLOR 3500K/ 4000K /5000K	22.0" x 21.4" x 1.9"	
RP-TRV-2X4-40W-40K-WC-TAA	FLEXWATT / 24W/30W/ 40W	3000/3750/ 5000		22.0" x 45.4" x 1.9"	
RP-TRF-2X2-24W-40K-WC-TAA	FLEXWATT / 16W/20W/ 24W	2000/2500/ 3000	FLEXCOLOR 3500K/ 4000K /5000K	22.0" x 21.4" x 1.5"	
RP-TRF-2X4-40W-40K-WC-TAA	FLEXWATT / 24W/30W/ 40W	3000/3750/ 5000		22.0" x 45.4" x 1.5"	

DEFAULT WATTAGE, LUMENS AND CCT ARE SHOWN IN BOLD



SENSOR READY



CONTROL READY PORT



OPTIONAL NETWORK LIGHTING CONTROL



OPTIONAL SIMPLE OCC



OPTIONAL EMG BATTERY BACKUP



EFFICACY*



CRI



BEAM ANGLE



OPERATING TEMP



SURGE PROTECTION



50,000hrs RATED LIFE

* TROFFER RETROFIT KITS HAVE AN EFFICACY OF 125LPW.



CHOOSE FROM 6 MODELS – HID EQUIVALENCE UP TO 400W...



RP-SAL-8/30W

OFF-GRID AREA LIGHTS

PART #	COMPARES TO	WATTAGE	LUMENS	CCT	EPA	DIMENSIONS	LISTINGS
RP-SAL-8W-50K-SF-GY-G2	70W HID	8W	1600	5000K	1.82	20.0" x 12.0" x 3.0"	
RP-SAL-8W-50K-SF-DB-G2							
RP-SAL-30W-50K-SF-GY-G2	250W HID	30W	6000	5000K	4.79	36.0" x 16.8" x 3.8"	
RP-SAL-30W-50K-SF-DB-G2							
● RP-SAL-8W-AMB-SF-GY-G2	70W HID	8W	284	580nm AMBER	1.82	20.0" x 12.0" x 3.0"	
● RP-SAL-8W-AMB-SF-DB-G2							
● RP-SAL-30W-AMB-SF-GY-G2	250W HID	30W	806		4.79	36.0" x 16.8" x 3.8"	
● RP-SAL-30W-AMB-SF-DB-G2							

OPERATING MODES | TIMER MOTION SENSING

AREA LIGHTS



100% POWERED BY THE SUN – NO TRENCHING OR WIRING...



SCAN FOR POLE OFFERINGS + ACCESSORIES



↑ SL-SAL-60L

OFF-GRID AREA LIGHTS

PART #	COMPARES TO	WATTAGE	LUMENS	CCT	EPA	DIMENSIONS	LISTINGS
SL-SAL-60L-FC-T3-BK-G3	250W HID	30W	6000	FLEXCOLOR 3000K/4000K/5000K	4.5	36.0" X 26.0" X 32.0"	coming soon
SL-SAL-OG-50W-50K-SF-BK-G2*	400W HID	50W	9800	5000K	6.1	11.2" x 7.0" x 16.3" (FIXTURE) 31.8" x 31.5" (SOLAR PANEL)	CE FC

OPERATING MODES | TIMER | MOTION SENSING



CERTIFIED BATTERY



RP-SAL



SL-SAL



RP-SAL



SL-SAL



BATTERY LIFE



REPLACEABLE BATTERY

FIXTURE OPERATING TEMP



-4°F TO 122°F

RP-SAL



-40°F TO 140°F

SL-SAL



MOTION SENSING



100,000hrs RATED LIFE

EXCLUSIVE LONG-LASTING BATTERY FOR LISTING STATUS GO TO LED-LLC.COM * WHILE SUPPLIES LAST.

SOLERA SOLAR / OFF-GRID



INTELLIGENT MODULAR AREA LIGHT

PART #	LUMENS	CCT	EPA	DIMENSIONS
SL-MA1-OG-1000634B1	ADJUSTABLE UP TO 10,000	FLEXCOLOR 3000K/4000K/5000K	8.0	SOLAR PANEL 27.1" x 19.2" x 2.2"
SL-MA1-HYB-1000634B1				

OPERATING MODES | CONSTANT BRIGHTNESS MOTION SENSING

HYBRID | POWERED BY THE SUN & BACKED UP BY LINE-VOLTAGE **OFF-GRID** | 100% POWERED BY THE SUN



STANDARD



OPTIONAL*



CERTIFIED BATTERY



BATTERY CHARGE TIME



FULL POWER ALL NIGHT**



BATTERY CHARGE TEMP



BATTERY LIFE**



REPLACEABLE BATTERY



-40°F TO 140°F
FIXTURE OPERATING TEMP



OPTIONAL MOTION SENSING



100,000hrs RATED LIFE

* 10 YEAR WARRANTY AVAILABLE AT AN ADDITIONAL COST. **BATTERY LIFE DEPENDS ON ENVIRONMENT AND POWER SETTINGS

INTELLIGENT MODULAR AREA LIGHT



PROFESSIONAL-GRADE, CONFIGURABLE, SOLAR-POWERED LIGHTING SYSTEM...

- ... ACCESS SOLERA
CONNECT VIA THE WEB
OR MOBILE APP
- ... MONITOR LIGHT LEVELS
THROUGHOUT THE DAY
- ... MAP YOUR PROJECTS

Hello
Welcome to use Solera Monitoring System 3.0 English

Solera

.....

Remember Me

Log In

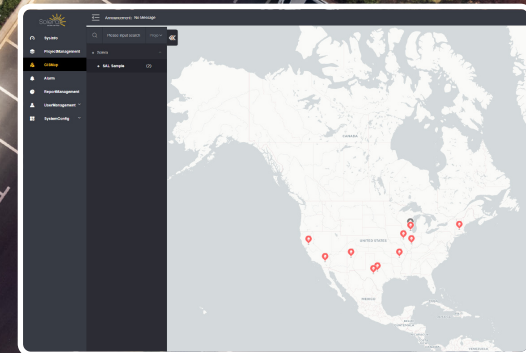
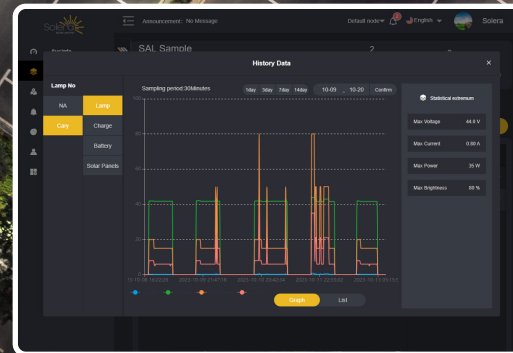

EXAMPLE OF CUSTOMER DASHBOARD

BUILD AND REMOTELY PROGRAM, CONTROL AND MONITOR AN INTELLIGENT SOLAR LIGHTING NETWORK. GRAPHICALLY SHOW USAGE AND DEMAND. TRACK SOLAR ENERGY GENERATION FOR SUSTAINABILITY REPORTING AND POSSIBLE TAX CREDITS.

CONFIGURE THE INTELLIGENT MODULAR AREA LIGHT TO FIT YOUR APPLICATION Area lighting, pedestrian lighting, billboard lighting and more. Available as a retrofit kit for sites with existing poles or purchase with pole kit, if needed.

REMOTELY SET UP YOUR NETWORK W/ SOLERA CONNECT Create one or more projects. Preset programming modes make programming lights and sensor settings quick and easy. Site grouping and custom control setup.

BI-DIRECTIONAL COMMUNICATION OVER A CELLULAR NETWORK Allows for remote monitoring and control of the solar collection, battery state, and lighting parameters. Each light included in a project is individually accessible. Get status updates to be alerted to unexpected conditions.



IMPROVE PEDESTRIAN SAFETY...



← SL-SBL-2W



SL-SPT-20W ↑

OFF-GRID BOLLARD LIGHT

PART #	COMPARES TO	LUMENS	CCT	DIMENSIONS	LISTINGS
SL-SBL-2W-27K-BK-G1	30W HALOGEN	266	2700K	8.0" x 30.0"	CE FC
SL-SBL-2W-40K-BK-G1			4000K		

OPERATING MODE

☀️ DUSK TO DAWN

OFF-GRID

PART #	COMPARES TO	LUMENS
SL-SPT-20W-30K-SF-G2	150W HID	2000
SL-SPT-20W-40K-SF-G2		

OPERATING MODES

☀️ DUSK TO DAWN | ⌚️ TIMER | 🚶️ MOTION SENSING



BATTERY CHARGE TIME



BATTERY CHARGING TEMP



BATTERY LIFE



BEAM ANGLE



-13°F TO 140°F

OPERATING TEMP



100,000hrs RATED LIFE



BATTERY CHARGE TIME



BATTERY CHARGING TEMP



BATTERY LIFE

BOLLARD + POST TOPS



THREE UNIQUE MODELS, PERFECT FOR PATHWAYS, PIERS AND MORE...



↑ SL-CPT

POST TOP LIGHT

CCT	DIMENSIONS	EPA	LISTINGS
3000K	16.0" x 32.0"	2.2	CE FC
4000K			

SCAN FOR POLE OFFERINGS + ACCESSORIES



OFF-GRID PATHWAY LIGHT

PART #	COMPARES TO	LUMENS	CCT	DIMENSIONS	EPA	LISTINGS
SL-CPT-25L-30K-BK-G1	150W	2500	3000K	21.3" x 13.4"	1.0 SF	CE FC
SL-CPT-25L-40K-BK-G1			4000K			

OPERATING MODES

☀️ CONSTANT BRIGHTNESS | 🕒 TIMER | 🚶 MOTION SENSING

SCAN FOR POLE OFFERINGS + ACCESSORIES



BEAM ANGLE



-4°F TO 149°F

OPERATING TEMP



100,000hrs
RATED LIFE



3
YEAR
WARRANTY



7-8
HRS
BATTERY
CHARGE TIME



32°F
TO
122°F
BATTERY
CHARGING TEMP



UP TO
30
HRS
BATTERY LIFE*



BEAM ANGLE



-4°F TO 122°F

OPERATING TEMP



50,000hrs
RATED LIFE

* ON 2HR + SENSOR MODE.

SOLERA SOLAR / OFF-GRID



...ADJUSTABLE – LIGHT EXACTLY WHERE YOU NEED IT



← SL-SFL-20W



SL-SDL-20W ↑

OFF-GRID FLOOD LIGHT

PART #	COMPARES TO	LUMENS	CCT	DIMENSIONS	ADJ HEIGHT	LISTINGS
SL-SFL-20W-40K-BK-G2	150W HID	2000	4000K	26.0" x 11.0" (PANEL w/ LIGHT)	16" TO 21"	CE FC

OPERATING MODE

☀️ CONSTANT BRIGHTNESS | ⌚ TIMER

OFF-GRID

PART #	COMPARES TO	LUMENS
SL-SDL-2FT-40K-BK-G2	70W HID	750
SL-SDL-4FT-40K-BK-G2	150W HID	2000

ACCESSORIES

RP-SDL-BK-LB	7" CLAMP MOUNT BRKT (2 PK)
--------------	----------------------------



BATTERY CHARGE TIME



BATTERY CHARGING TEMP



BATTERY LIFE



BEAM ANGLE



OPERATING TEMP



50,000hrs RATED LIFE

SURFACE MOUNT BRACKET INCLUDED



BATTERY CHARGE TIME



BATTERY CHARGING TEMP

FLOOD + DISPLAY + MULTIFUNCTIONAL LIGHTS



USE LIGHT ENGINE AS A POWER BANK...



↑ SL-SMFL-10W

DISPLAY LIGHT

CCT	DIMENSIONS	LISTINGS
4000K	23.6" x 4.3" x 4.3"	CE FC
4000K	47.2" x 4.3" x 4.3"	

OPERATING MODES

☀️ CONSTANT BRIGHTNESS | 🕒 TIMER

OFF-GRID MULTIFUNCTIONAL FLOOD LIGHT

PART #	COMPARES TO	LUMENS	CCT	DIMENSIONS	LISTINGS
SL-SMFL-10W-40K-BK-G1	70W HID	1100	4000K	9.1" x 6.5" (LIGHT) 13.6" x 9.3" (PANEL)	CE FC

OPERATING MODES

☀️ CONSTANT BRIGHTNESS | 🕒 TIMER | 🚶 MOTION SENSING



BATTERY LIFE



BEAM ANGLE



OPERATING TEMP



50,000hrs RATED LIFE



3 YEAR WARRANTY



BATTERY CHARGE TIME



BATTERY CHARGING TEMP



BATTERY LIFE



BEAM ANGLE



OPERATING TEMP



50,000hrs RATED LIFE



...ALL-IN-ONE DESIGN

MAKE IT MAGNETIC ↓

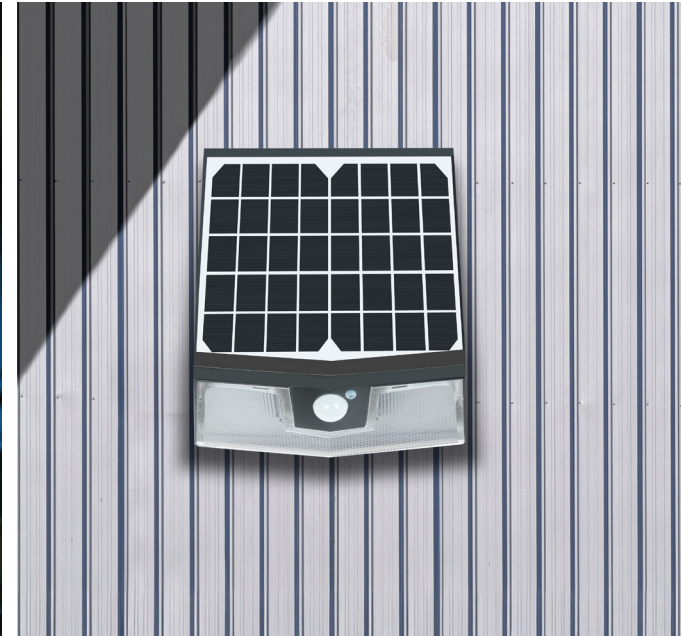

SL-SWL-15W ↑

OFF-GRID WALL PACK

PART #	COMPARES TO	LUMENS	CCT	DIMENSIONS	LISTINGS
SL-SWL-15W-40K-BK-G2	100W HID	1500	4000K	10.0" x 12.0" x 5.0"	CE FC
SL-SWL-15W-40K-BK-G2-M					

OPERATING MODES

☀️ DUSK TO DAWN | 🕒 TIMER | 🚶 MOTION SENSING



BATTERY CHARGE TIME



BATTERY CHARGING TEMP



BATTERY LIFE



BEAM ANGLE



OPERATING TEMP



35,000hrs RATED LIFE



EACH MAGNET HOLDS UP TO 35 LBS. FOR A TOTAL PULL STRENGTH OF 140 LBS.

MAGNETIC MOUNTING



DETACHABLE SOLAR PANEL...

**BUILT TO WITHSTAND
EXTREME CLIMATES**



SL-SWL-16L

OFF-GRID FLEXCOLOR WALL PACK

PART #	COMPARES TO	LUMENS	CCT	DIMENSIONS	LISTINGS
SL-SWL-16L-FC-BK-G3	100W HID	1600	FLEXCOLOR 3000K/4000K/5000K	13.0" X 12.0" X 5.0"	CE FC
SL-SWL-16L-FC-BK-G3-M					

OPERATING MODES

☀️ CONSTANT BRIGHTNESS | 🚶 MOTION SENSING



DETACHABLE
SOLAR PANEL



MAGNETIC MOUNTING

L2 | ELECTRIC VEHICLE CHARGERS

R40 / R48
**NON-NETWORKED
RFID CHARGING***
UP TO 48A
CHARGING POWER



P48 / P80
**NETWORKED
SMART CHARGING**
UP TO 48A
CHARGING POWER



S48
**NON-NETWORKED
PLUG + CHARGE**
UP TO 48A CHARGING POWER



P80d
**DUAL PORT SMART
CHARGING**
UP TO 80A
CHARGING POWER

POWERED BY
AUTEL®

* 5 RFID CARDS INCLUDED.

D-SERIES DC COMPACT CHARGER / 40kW

PROVIDES UP TO
80 MILES OF RANGE IN
30 MINUTES



C-SERIES

DC FAST CHARGER
60kW-240kW

PROVIDES UP TO
125 MILES OF RANGE IN
10 MINUTES

F-SERIES

DC HiPOWER CHARGER
480KW-640kW

PROVIDES UP TO 250 MILES
OF RANGE IN 10 MINUTES

POWERED BY **AUTEL**

LEVEL 2, NON-NETWORKED CHARGING



INSTALL ON A PEDESTAL OR WALL MOUNT...



PART #	CHRG AMPS	CONNECTOR	NETWORK	USER INTERFACE	OCPP SOFTWARE	UNIT DIMENSIONS	LISTINGS
R40 ALL-IN-ONE KIT (INCLUDES CHARGER W/ 18 FT OR 25 FT, 10AWG, 40A CABLE)							
EVC-L2-R40-18	UP TO 40A	SAE J1772	RFID	N/A	N/A	9.8" x 14.2" x 3.9"	
EVC-L2-R40-25							
R48 ALL-IN-ONE KIT (INCLUDES CHARGER W/ 18 FT OR 25 FT, 8AWG, 48A CABLE)							
EVC-L2-R48-18	UP TO 48A	SAE J1772	RFID	N/A	N/A	9.8" x 14.2" x 3.9"	
EVC-L2-R48-25							
R40 / R48 IN THE BOX							
	18 FT (R40-18/R48-18) OR 25 FT (R40-25/R48-25) OUTPUT CORD W/ SAE J1772 CONNECTOR			5 RFID CARDS		MOUNTING HARDWARE + INSTRUCTIONS	



* 5 YEAR EXTENDED WARRANTY AVAILABLE. CONTACT SALES REPRESENTATIVE

NO NETWORK NEEDED – SIMPLY PLUG + CHARGE





SCAN FOR MORE INFO ON PEDESTALS + MOUNTING OPTIONS



PART #	CHRG AMPS	CONNECTOR	NETWORK	USER INTERFACE	OCPP SOFTWARE	UNIT DIMENSIONS	LISTINGS
S48 ALL-IN-ONE KIT (INCLUDES CHARGER W/ 18 FT OR 25 FT, 8AWG, 48A CABLE)							
EVC-L2-S48-18	UP TO 48A	SAE J1772	N/A	N/A	N/A	8" x 9.2" x 4"	 
EVC-L2-S48-25							

S48 | IN THE BOX

 <p>1 FT INPUT CORD W/ NEMA 14-50 PLUG (ATTACHED TO UNIT)</p>	 <p>18 FT (S48-18) OR 25 FT (S48-25) OUTPUT CORD W/ SAE J1772 CONNECTOR</p>	 <p>CABLE HOOK W/ HOLSTER + BACKPLATE</p>	<p>MOUNTING HARDWARE + INSTRUCTIONS</p>
--	--	--	---

LEVEL 2 EV CHARGER TESTER







PART #	DESCRIPTION
EVC-L2-ACC-TESTER-J1772	VERIFY THE CORRECT OPERATION AND SETTING OF AN EV CHARGER AFTER INSTALLATION, W/O AN ELECTRIC VEHICLE PRESENT



LEVEL 2, NETWORKED SMART CHARGING

PERFECT FOR
MULTI-UNIT HOUSING,
OR RETAIL PROPERTIES...



PART #	CHRG AMPS	CONNECTOR	CABLE LENGTH	NETWORK	USER INTERFACE	OCPP SOFTWARE	UNIT DIMENSIONS	LISTINGS
P48 ALL-IN-ONE KITS (INCLUDES CHARGER W/ 48A CABLE SET)								
 EVC-L2-48A-L1-1-4G-D	UP TO 48A	SAE J1772	18FT	ETHERNET/RFID/4G	LCD DISPLAY	1YR AMPUP PRO	9.8" x 13.8" x 5.1"	 
 EVC-L2-48A-L1-1-4G-D-25			25FT					
P80 ALL-IN-ONE KIT (INCLUDES CHARGER W/ 80A CABLE SET)								
 EVC-L2-P80-18-AP1	UP TO 80A	SAE J1772	18FT	ETHERNET/RFID/4G	LCD DISPLAY	1YR AMPUP PRO	9.8" x 13.8" x 5.1"	 

EQUIPPED W/ LCD SCREEN, RFID, OCPP NETWORK

INSTALL ON A PEDESTAL OR WALL MOUNT...



SCAN FOR MORE INFO ON PEDESTALS + MOUNTING OPTIONS



PART #	DESCRIPTION	PART #	DESCRIPTION
PEDESTALS / ACCESSORIES			
EVC-L2-ACC-LPK2	LOWER PEDESTAL KIT FOR L2 CHARGER	EVC-L2-ACC-CM	CABLE MGMT FOR PEDESTAL W/ 2 RETRACTORS
EVC-L2-ACC-SSB	BRACKET FOR SIDE-BY-SIDE CHARGERS	EVC-L2-ACC-CM1	CABLE MGMT FOR PEDESTAL W/ 1 RETRACTOR
EVC-L2-ACC-ANCHOR KIT WET	WET CONCRETE ANCHOR KIT	EVC-L2-ACC-CMR	CABLE RETRACTOR W/ SPRING LOADED TETHER
EVC-L2-ACC-MAKE READY BASE	CHARGING STATION FOUNDATION	EVC-L2-ACC-HAD	HOOK/HOLSTER FOR WALL MOUNTING

LEVEL 2 EV CHARGER TESTER

PART #	DESCRIPTION
EVC-L2-ACC-TESTER-J1772	VERIFY THE CORRECT OPERATION AND SETTING OF AN EV CHARGER AFTER INSTALLATION, W/O AN ELECTRIC VEHICLE PRESENT



LEVEL 2, NETWORKED SMART CHARGING

8-INCH HD
ADVERTISING
SCREEN...

UNIT W/ PEDESTAL
MOUNT SHOWN...

PART #	MODEL #	DESCRIPTION
P80D		
BEV-L2-P80D-18-CM-P	MU38FP5C	DUAL 80A CHARGER, 18' 80A CABLE SET, 4G CELLULAR, POS, PEDESTAL MOUNT, CABLE MANAGMENT
BEV-L2-P80D-18	UF38C001	DUAL 80A CHARGER, 18' 80A CABLE SET, 4G CELLULAR, WALL-MOUNT
BEV-L2-P80D-25-CM-P	MU38FP7C	DUAL 80A CHARGER, 25' 80A CABLE SET, 4G CELLULAR, POS, PEDESTAL MOUNT, CABLE MANAGMENT
BEV-L2-P80D-25	UF38L001	DUAL 80A CHARGER, 25' 80A CABLE SET, 4G CELLULAR, WALL-MOUNT

EQUIPPED W/ LCD SCREEN, RFID, OCPP NETWORK



PART #	MODEL #	DESCRIPTION
ACCESSORIES		
BEV-L2-P80D-PP	FPP	P80 PEDESTAL POST
BEV-L2-P80D-CM6	CMSB2	D80P-18 6' CABLE MANAGEMENT SYSTEM
BEV-L2-P80D-CM9	CMSA2	D80P-25 9' CABLE MANAGEMENT SYSTEM
BEV-L2-P80D-POS	POSA	D80P POS TERMINAL

POWERED BY **AUTEL**[®]**LEVEL 3, NETWORKED SMART CHARGING**

...INSTALL ON A PEDESTAL
OR MOVABLE TROLLEY

... FOR PEOPLE & BUSINESSES WHERE
TIME IS THE MOST VALUED ASSET

PART #	MODEL #	DESCRIPTION
C-SERIES DC COMPACT CHARGER		
BEV-L3-C40-25-PM	DC40APN25	DUAL 40KW COMPACT DCFC 25 FT PEDESTAL MOUNT CABLE/CCS1
BEV-L3-C40-25-PPM	DC40APC25	DUAL 40KW COMPACT DCFC 25 FT PEDESTAL MOUNT CABLE/CCS1 W/ POS
BEV-L3-C40-25-T	DC40ATN25	DUAL 40KW COMPACT DCFC 25 FT TROLLEY CABLE/CCS1

PART #	MODEL #	DESCRIPTION
D-SERIES DC FAST CHARGER		
BEV-L3-D60	UF060A3001	60KW UL DUAL PORT DCFC
BEV-L3-D120	UF120A3001	120KW UL DUAL PORT DCFC
BEV-L3-D180L	UF180A4001	180KW UL DUAL PORT DCFC
BEV-L3-D240L	UF240A4001	240KW UL DUAL PORT DCFC



...PERFECT FOR HIGHWAY REST-STOPS,
GAS STATIONS AND FLEET MANAGEMENT



PART #	MODEL #	DESCRIPTION
F-SERIES DC HI-POWER CHARGER		
BEV-L3-F480-2B	US480A2L0	480KW DCFC, 2 DISPENSERS 4 PORTS: BOOST 16' CABLE/CCS1 CABLE MANAGEMENT
BEV-L3-F480-2LC	US480A0L2	480KW DCFC, 2 DISPENSERS 4 PORTS: LIQUID COOLED 16' CABLE/CCS1 CABLE MANAGEMENT
BEV-L3-F640-2B	US640A2L0	640KW DCFC, 2 DISPENSERS 4 PORTS: BOOST 16' CABLE/CCS1 CABLE MANAGEMENT
BEV-L3-F640-2LC	US640A0LC2	640KW DCFC, 2 DISPENSERS 4 PORTS: LIQUID COOLED 16' CABLE/CCS1 CABLE MANAGEMENT

INCLUDES...
2 POWER DISPENSERS
AND A NONDESCRIPT
POWER CABINET.



CORPORATE HQ & TRAINING CENTER • CARY, IL | INNOVATION & MANUFACTURING CENTER • Middleton, MA
847.380.3540 • led-llc.com • sales@led-llc.com