



 **Light Efficient Design**

RemPhos

Solera 

 **breezEV**













Light Efficient Design



LEADING THRU INNOVATION

Light Efficient Design



120-277V PART #	347V PART #	REPLACES	WATTAGE	LUMENS	CCT	BASE	DIMENSIONS	LISTINGS	
BOLLARD + POST TOP BALLAST BYPASS TYPE B									
LED-8037E345-A		50W	11W	1550/1610/1650		E26	2.6" x 5.3"	 FLEXCOLOR 3000K/4000K/5000K	
LED-8038E345-A	LED-8038E345C-A	70W	14W	1850/1950/1990		E26	2.6" x 5.3"		
LED-8039E345D-A	LED-8039E345C-A	100W	18W	2450/2560/2610		E26	2.6" x 6.3"		
LED-8039M345D-A	LED-8039M345C-A					EX39	2.6" x 7.0"		 
LED-8029E345-A-FW	LED-8029E345C-A-FW	70W/100W/150W	FLEXWATT 12W/18W/24W	1550-3360		E26	3.0" x 6.6"	 FLEXCOLOR 3000K/4000K/5000K	
LED-8029M345-A-FW	LED-8029M345C-A-FW					EX39	3.0" x 6.9"		 
LED-8024E345-G7-FW	LED-8024E345C-G7-FW	175W/250W/320W	FLEXWATT 35W/45W/60W	5140-8870		E26	3.4" x 7.4"		
LED-8024M345-G7-FW	LED-8024M345C-G7-FW					EX39	3.4" x 7.8"		
LED-8027M345-G7-FW		320W/400W	FLEXWATT 80W/100W/110W	11370-15730		EX39	3.8" x 9.5"		 
HV LED-8027M345-G7-FW-HV	LED-8027M345-G7-FW-HV								
LED-8075M345-FW		750W	FLEXWATT 300W/360W/450W	50100-73300		EX39	5.6" x 12.3"	 FLEXCOLOR 3000K/4000K/5000K	
HV LED-8075M345-FW-HV	LED-8075M345-FW-HV	750W							
MV LED-8000M345-FW-MV	LED-8000M345-FW-MV	1000W	FLEXWATT 150W/200W/270W	21700-39000					
HV LED-8000M345-FW-HV		1000W							
LED-8033E30D-G7		175W	35W	5140	3000K	E26	3.4" x 7.2"		
LED-8033E40D-G7				5290	4000K				
LED-8033E50D-G7				5360	5000K				
LED-8033M30D-G7				5140	3000K	EX39	3.4" x 7.8"		 
LED-8033M40D-G7				5290	4000K				
LED-8033M50D-G7				5360	5000K				

DEFAULT WATTAGE AND CCT FOR SUPERFLEX LAMPS ARE SHOWN IN BOLD.

SIZE COMPARISON

SMALLER BECAUSE SIZE DOES MATTER

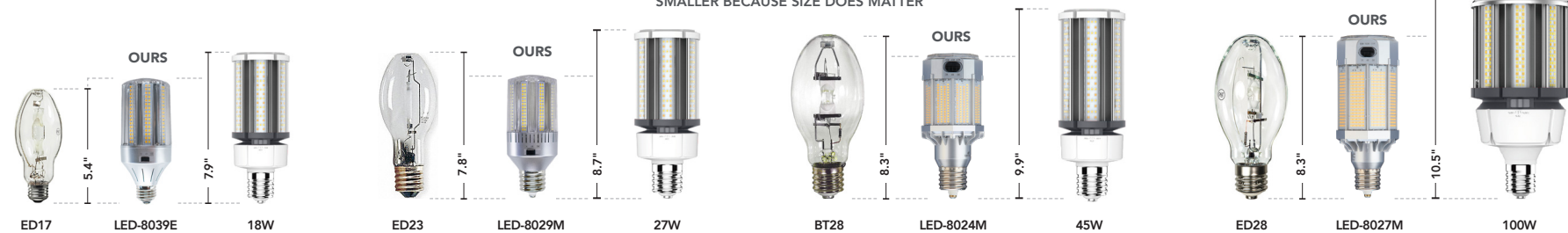

ACTIVE COOLING HV 277-480V INCLUDING 347V MV 208-347V  FOR LISTING STATUS GO TO LED-LLC.COM

BOLLARD + POST TOP



9 MODELS REPLACING UP TO 1000W HID. Keep the look and feel of your existing fixture, while saving energy and maintenance costs. Several models feature FlexWATT and FlexCOLOR allowing for substantial sku reduction and in-field adjustability.



LED-8038 →



LED-8000 →

LED-8024 →

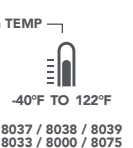
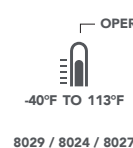
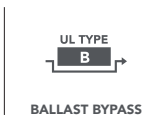

MULTIPLE VOLTAGE OPTIONS ON 8000 INCLUDING 480V

& LONGER NECK TO BETTER FIT FIXTURES



* EXCLUDES 8037-39 MODELS.

LIGHT EFFICIENT DESIGN / SCREW-IN RETROFITS

120-277V PART #	REPLACES	WATTAGE	LUMENS	CCT	BASE	DIMENSIONS	LISTINGS	
BOLLARD + POST TOP BALLAST BYPASS TYPE B								
LED-8015E30-G2	100W INC 70W HID	14W	1792	3000K	E26	2.6" x 5.3"	 	
LED-8015E40-G2			1918	4000K				
LED-8015E50-G2			1960	5000K				
 LED-8017E30-G2-DIM*	150W INC 100W HID	20W	2540	3000K	E26	2.6" x 5.3"		
 LED-8017E40-G2-DIM*			2720	4000K				
 LED-8017E50-G2-DIM*			2760	5000K				
LED-8017E345-G3	150W INC / 100W HID	20W	2400/ 2700 /2600	FLEXCOLOR 3000K/ 4000K /5000K	E26	2.8" x 5.5"		
LED-8018E345-G3	200W INC / 150W HID	25W	3000/ 3375 /3250			3.4" x 6.8"		
LED-8019E345-G3	300W INC / 175W HID	35W	4200/ 4725 /4550			EX39		
LED-8019M345-G3	175W HID				EX39	3.9" x 7.9"		
LED-8020M345-G3	250W HID	45W	5400/ 6075 /5850		EX39	4.7" x 9.2"		
LED-8021M345-G3	320W HID	65W	7800/ 8775 /8450					
LED-8060E22	100W HID	15W	2250		2200K	E26	2.2" x 6.4"	
LED-8060E40			2700	4000K				
LED-8060E50				5000K				
LED-8061E22	150W HID	28W	3500	2200K	E26	3.0" x 7.6"		
LED-8061E40			4000	4000K				
LED-8061E50				5000K				
LED-8062M22	175W HID	32W	4500	2200K	EX39	3.5" x 9.4"		
LED-8062M40			5500	4000K				
LED-8062M50				5000K				
LED-8063M22	250W HID	45W	6000	2200K	EX39	3.5" x 9.4"		
LED-8063M40			7500	4000K				
LED-8063M50				5000K				
LED-8064M22	320W HID	54W	8000	2200K	EX39	4.9" x 9.4"		
LED-8064M40			10000	4000K				
LED-8064M50				5000K				
LED-8065M22	400W HID	85W	13600	2200K	EX39	4.8" x 11.5"		
LED-8065M40			15725	4000K				
LED-8065M50				5000K				

DEFAULT LUMENS AND CCT FOR FLEXCOLOR LAMPS ARE SHOWN IN BOLD.

* LED-8017-G2-DIM IS 120V ONLY. DIMMABLE ON MOST 120V LED RATED DIMMERS, PLEASE SEE WEBSITE FOR LIST OF COMPATIBLE DIMMERS.

 FROSTED LENS  DIMMABLE  INC INCANDESCENT  FOR LISTING STATUS GO TO LED-LLC.COM

BOLLARD + POST TOP



12 MODELS REPLACING UP TO 400W HID. Perfect for post top and bollard fixtures, these retrofits feature frosted lenses (801X + 802X models only) and shapes that closely mimic the outgoing lamp technology. Because of their traditional shapes, several feature Energy Star.



FROSTED LENS

AVAILABLE IN 2200K, 4000K & 5000K

LED-8018 →

← LED-8062

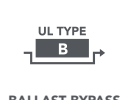

* ALSO WORKS ON 208V & 240V. LED-8017-G2-DIM IS 120V ONLY.

LIGHT EFFICIENT DESIGN / SCREW-IN RETROFITS

120-277V PART #	347V PART #	REPLACES	WATTAGE	LUMENS	CCT	BASE	DIMENSIONS	LISTINGS
SHOE BOX + WALL PACK BALLAST BYPASS TYPE B								
LED-8086E30-G4		70W	20W	2800	3000K	E26	2.6" x 5.2"	cUL US LISTED
LED-8086E40-G4				2800	4000K			
LED-8086E50-G4				2880	5000K			
LED-8087E345D-G4	LED-8087E345CD-G4	100W	30W	3500/ 4200 /4300	3000K	E26	3.0" x 6.4"	cUL US LISTED
LED-8087M345D-G4	LED-8087M345CD-G4					EX39	3.0" x 6.9"	cUL US LISTED
LED-8088E345D-G4	LED-8088E345CD-G4					E26	3.8" x 7.9"	cUL US LISTED
LED-8088M345D-G4	LED-8088M345CD-G4	175W	50W	6400/ 6900 /7200	3000K/ 4000K /5000K	EX39	3.8" x 8.5"	cUL US LISTED
LED-8089M345D-G4	LED-8089M345CD-G4						4.3" x 10.0"	
LED-8090M345D-G4	LED-8090M345D-G4						4.3" x 11.4"	
HV LED-8090M345D-G4-HV	LED-8090M345D-G4-HV	400W	110W	14500/ 15400 /15700				
LED-8089M30D-G5		250W	80W	10670	3000K	EX39	4.3" x 8.3"	cUL US LISTED
LED-8089M40D-G5				10760	4000K			
LED-8089M50D-G5				10850	5000K			
LED-8091M40D		1000W	320W	43380	4000K	EX39	9.0" x 12.7" (PANEL) 4.7" x 11.2" (DRIVER)	cUL US LISTED
LED-8091M50D				44610	5000K			
HV LED-8091M40D-HV				LED-8091M40D-HV	1000W			
HV LED-8091M50D-HV	LED-8091M50D-HV			44610	5000K			

DEFAULT LUMENS AND CCT FOR FLEXCOLOR LAMPS ARE SHOWN IN BOLD.

SIZE COMPARISON

SMALLER BECAUSE SIZE DOES MATTER

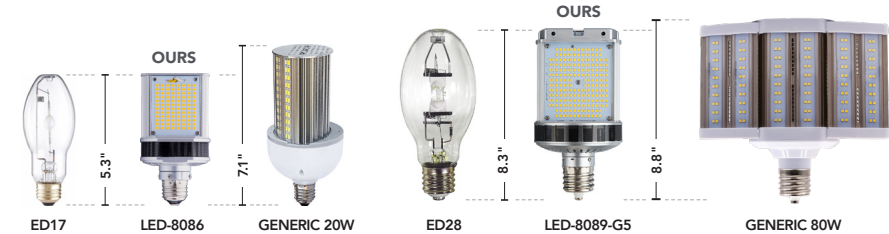

LIGHT DISTRIBUTION / FOOT CANDLE COMPARISON / DLC POLE-MOUNTED FIXTURES

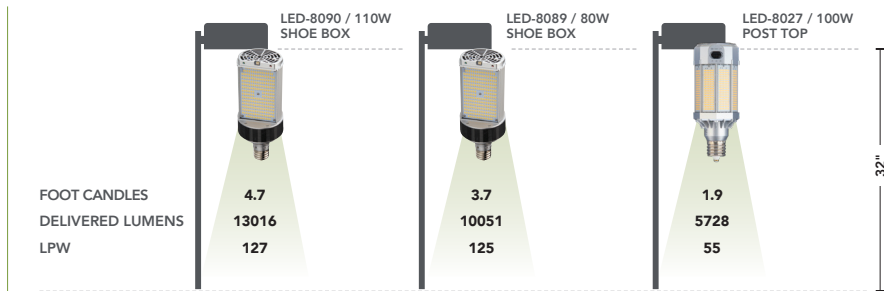

SHOE BOX + WALL PACK



7 MODELS REPLACING UP TO 1000W HID. Retrofit almost any shoe box or wall pack fixture to energy & maintenance saving LEDs. Eliminate ballast failures. FlexCOLOR on several models allows for less stocked inventory as well as field adjustability.









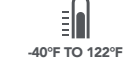







LED PANEL ADHERES TO FIXTURE LENS



ROTATABLE BASE – DIRECTS LUMENS OUT OF FIXTURE



120-277V PART #	347V PART #	REPLACES	WATTAGE	LUMENS	CCT	BASE	DIMENSIONS	LISTINGS
HIGH BAY BALLAST BYPASS TYPE B								
LED-8136M40D	LED-8136M40CD	250W	90W	12400	4000K	EX39	8.7" x 9.3"	 
LED-8136M50D	LED-8136M50CD			12900	5000K			
LED-8132M40D	LED-8132M40CD	400W	135W	18600	4000K	EX39	8.7" x 10"	
LED-8132M50D	LED-8132M50CD			19200	5000K			
 LED-8130M40D	LED-8130M40CD	400W	150W	20900	4000K	EX39	8.7" x 10"	
 LED-8130M50D	LED-8130M50CD			21200	5000K			
LED-8236M345D	LED-8236M345CD	250W	95W	13700/14400/14600	FLEXCOLOR 3000K/4000K/5000K	EX39	8.7" x 9.7"	 
LED-8232M345D		400W	140W	19900/20900/21100		EX39	8.7" x 10.5"	
HV LED-8232M345D-HV	LED-8232M345D-HV					EX39	10.3" x 12.5"	
LED-8242M40D		1000W	270W	38400	4000K	EX39	10.3" x 12.5"	
LED-8242M50D				38700	5000K			
HV LED-8242M40D-HV	LED-8242M40D-HV			38400	4000K	EX39		
HV LED-8242M50D-HV	LED-8242M50D-HV			38700	5000K			
HIGH BAY BALLAST COMPATIBLE TYPE A								
 LED-8030M40-MHBC		400W	140W	18619	4000K	EX39	9.1" x 9.2"	 
 LED-8030M57-MHBC				17047				
LOW BAY BALLAST BYPASS TYPE B								
LED-8056E40D-A		175W	45W	5334	4000K	E26	5.7" x 6.9"	
LED-8056E50D-A				5560	5000K			
LED-8056M40D-A				EX39	5334	4000K		
LED-8056M50D-A					5560	5000K		
 LED-8035E40-A		175W	60W	6684	4000K	E26	5.7" x 7.4"	
 LED-8035E57-A				7062	5700K			

LIGHT DISTRIBUTION / FOOT CANDLE COMPARISON / DLC CEILING-MOUNTED HIGH BAY FIXTURES

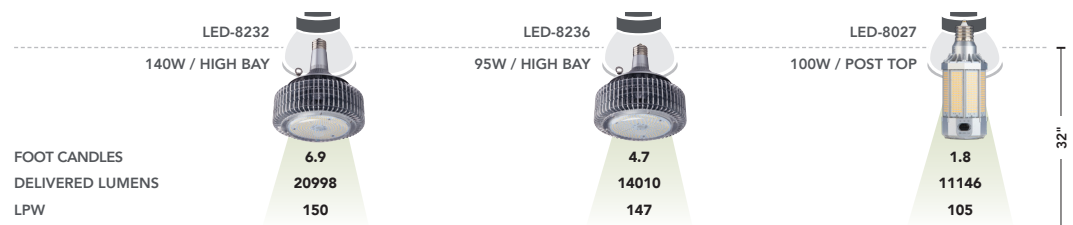

 OPEN FIXTURE ONLY  ENCLOSED FIXTURES  INCLUDES UPLIGHT HV 277/480V INCLUDING 347V  FOR LISTING STATUS GO TO LED-LLC.COM

HIGH BAY + LOW BAY



9 MODELS REPLACING UP TO 1000W HID. Ultra-bright LED retrofits for high ceiling environments. Models w/o active cooling for open fixtures & silent operation. Models w/ active cooling are safe to install in enclosed fixtures. Low bay retrofits are ideal for ceiling fixtures that require light to be pushed down & out. Angled LED panels help direct light exactly where it is needed.



POWERFUL PERFORMANCE – FOR HIGH BAY ENVIRONMENTS



* EXCLUDES 8030 AND 8035 MODELS. ** EXCLUDES 8100 MODELS.

LIGHT EFFICIENT DESIGN / SCREW-IN RETROFITS



120-277V PART #	347V PART #	REPLACES	WATTAGE	LUMENS	CCT	BASE	DIMENSIONS	LISTINGS
SOX BALLAST BYPASS TYPE B								
LED-8100-22K		35W	20W	2030	2200K	B22D	12.2" x 2.8"	cULus
LED-8100-40K				3022	4000K			
LED-8100-AMB*				NA	AMBER			
LED-8101-22K		55W	35W	3232	2200K		16.7" x 2.9"	
LED-8101-40K				5156	4000K			
LED-8101-AMB*				NA	AMBER			
LED-8102-22K		90W	60W	5769	2200K		20.5" x 2.8"	
LED-8102-40K				8198	4000K			
LED-8102-AMB				NA	AMBER			
LED-8104-22K		180W	100W	11576	2200K		43.5" x 2.8"	
LED-8104-40K				11576	4000K			
LED-8104-AMB*				NA	AMBER			

HAZARDOUS LOCATION BALLAST BYPASS TYPE B									
LED-8929E57-HAZ	LED-8929E57C-HAZ	150W	24W		3425	5700K	E26	3.0" x 6.6"	cULus LISTED
LED-8929M57-HAZ	LED-8929M57C-HAZ						EX39	3.0" x 6.9"	cULus LISTED cULus CLASSIFIED
LED-8924E50-HAZ	LED-8924E50C-HAZ	250W	49W (347V)	45W (120/277V)	6620	5000K	E26	3.4" x 7.8"	cULus LISTED
LED-8924M50-HAZ	LED-8924M50C-HAZ		EX39	3.4" x 7.8"			cULus LISTED cULus CLASSIFIED		

DEFAULT WATTAGE AND CCT FOR SUPERFLEX LAMPS ARE SHOWN IN BOLD.

SURGE ARRESTORS					
PART #	DESCRIPTION	ENCLOSURE	NOMINAL DISCHARGE CURRENT	STRIKE RATING	DIMENSIONS
SPD-277P-10KA-EC-1	10kA SURGE ARRESTOR, 120-277V, SERIES W/ THERMAL FUSE	ROUND IP65	10,000A	1@10kA, 2@6.5kA 15@3kA, 110@1.5kA	2.5" x 1.4"
SPD-347P-10KA	10kA SURGE ARRESTOR, 120-347V, SERIES W/ THERMAL FUSE	ROUND IP67			

STEP DOWN TRANSFORMERS						
PART #	DESCRIPTION	MAX WATTAGE	VOLTAGE	THD	POWER FACTOR	DIMENSIONS
MTM04506224C-LW	450VA STEP DOWN TRANSFORMER	400W	480/347V IN / 277V OUT	3.4% / 3.8%	0.99	4.2" x 2.7" x 2.2"
MTM01606224C-LW	160VA STEP DOWN TRANSFORMER	140W		4.3% / 4.1%	0.99	4.2" x 2.0" x 1.6"
MTM00506224C-LW	50VA STEP DOWN TRANSFORMER	45W	480/347V IN / 240V OUT	6.2% / 6.7%	0.98 / 0.97	3.0" x 1.7" x 1.4"

ENCLOSED FIXTURES LISTED FOR CLASS 1, DIV 2 HAZ LOCATIONS (SEE OUR WEBSITE FOR A LIST OF APPROVED FIXTURE) SUPPORT HARNESS INCLUDED TO ELIMINATE SOCKET SAG

SOX + HAZARDOUS LOCATION



THE MOST UNIQUE RETROFITS, BROUGHT TO YOU BY THE LEADER! Hazardous location fixtures are expensive, retrofitting them w/ UL approved lamps is NOT. Two wattages to choose from. SOX retrofits in 4 lengths to adequately fill out the long, narrow fixtures.



← LED-8101

LED-8924 →

4 LENGTH OPTIONS TO FILL THE ENTIRE FIXTURE

HAZARDOUS LOCATION – CLASS 1 DIV 2

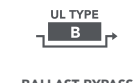

* ALSO WORKS ON 208V & 240V.

LIGHT EFFICIENT DESIGN / SCREW-IN RETROFITS



RECESSED CAN



120-277V PART #	REPLACES	WATTAGE	LUMENS	CCT	BEAM ANGLE	BASE	DIMENSIONS	LISTINGS
RECESSED CAN BALLAST BYPASS TYPE B								
LED-8054E27-G2	150W INC 100W HID	30W	2500	2700K	140°	E26	4.2" x 4.8"	
LED-8054E35-G2			3000	3500K				
LED-8054E40-G2			3000	4000K				
LED-8054E50-G2			3000	5000K				
LED-8054E35-G2-DIM*	150W INC 100W HID	30W	3000	3500K		E26		
LED-8054E40-G2-DIM*			3000	4000K				
LED-8054E50-G2-DIM*			3000	5000K				

* LED-8054-G2-DIM ARE 120V ONLY. DIMMABLE ON MOST 120V LED RATED DIMMERS, PLEASE SEE WEBSITE FOR LIST OF COMPATIBLE DIMMERS.



**FANLESS —
FOR SILENT OPERATION**



**EFFICIENT DIE-CAST ALUMINUM
HEAT SINK KEEPS THE FIXTURE COOL**



**RATED FOR DAMP LOCATION
& OPEN FIXTURE**

REPLACING 100W HID. Recessed can fixtures are one of the most common ways to light any commercial space. Our dimmable models will help save even more energy and make interior spaces more appealing.



QUICK & EASY ENERGY SAVINGS

DESIGNED WITH 140° BEAM ANGLE





TYPE A + B

FLEXCOLOR								FLEXCOLOR		
LED-7300-G2	LED-7310-G4	LED-7313-G4	LED-7314-G4	LED-7311-G4	LED-7312-G4	LED-7322-G4	LED-7316-G2	LED-7318/28-G2	LED-7320-G4	LED-7324-G4
GX23	G24d	G23	GX23	G23-2	GX23-2	G24d	G24d	G24q	G24q/GX24q	G24q/GX24q
2-PIN								4-PIN		

TYPE A

LED-7330-G2	LED-7334-G2
G24q/GX24q	G24q/GX24q

4-PIN

TYPE B

LED-7340-G3/7343-G3	7344-G3/7345-G3		
G211			

7340/43 /44 /45

4-PIN

OPEN FIXTURE ONLY ENCLOSED FIXTURE RATED (MAY ALSO BE USED IN OPEN FIXTURE)

OVER A DOZEN MODELS FOR THE PERFECT SOLUTION. Our latest pin-based LED retrofits now feature FlexCOLOR allowing for substantial sku reduction and in-field adjustability. Perfect for PL applications, and provide a long-lasting LED alternative for areas in offices, hotels, lobbies, schools, etc.



90° ROTATABLE HEAD



NOW WITH FLEXCOLOR...

& EXTENDED END CAP



7311 / 7312 / 7313
7314 / 7322 / 7324 / 7334

7340 / 7343
7344 / 7345

7316 / 7318 / 7328

7300 / 7310
7320 / 7330

50,000hrs
L70

LIGHT EFFICIENT DESIGN / PIN-BASE RETROFITS

* ALSO WORKS ON 208V & 240V.



PART #	REPLACES UP TO	WATTAGE	LUMENS	CCT	BASE	MOUNTING	DIMENSIONS	LISTINGS
PL UNIVERSAL TYPE A+B								
LED-7300-27K-G2	9W / 2-PIN CFL	5W	550	2700K	GX23	↕	5.5" x 1.4"	
LED-7300-35K-G2				3500K				
LED-7300-40K-G2				4000K				
LED-7300-50K-G2				5000K				
LED-7310-FC-G4	26W / 2-PIN CF	9W	1104-1243	FLEXCOLOR 2700/3000K/3500K/4000K	G24d	↕	6.9" x 1.4"	
LED-7313-FC-G4	9W / 2-PIN CFL	3.5W	389-428		G23	↕	5.3" x 1.3"	
LED-7314-FC-G4	13W / 2-PIN CFL	5.5W	628-696		GX23	↕	7.0" x 1.4"	
LED-7311-FC1-G4	26W / 2-PIN CFL	7W	900-950	FLEXCOLOR 3000K/3500K/4000K	G23-2	↔	5.5" x 1.4"	
LED-7312-FC1-G4					GX23-2			
LED-7322-FC1-G4					G24d			
LED-7320-FC1-G4	42W / 4-PIN CFL	10W	1400	FLEXCOLOR 3000K/3500K/4000K	G24q GX24q	↕	6.6" x 1.4"	
LED-7320-FC2-G4				FLEXCOLOR 2700K/4000K/5000K				
LED-7324-FC1-G4	42W / 4-PIN CFL	9W	1400	FLEXCOLOR 3000K/3500K/4000K	G24q GX24q	↔	5.7" x 1.3"	
LED-7324-FC2-G4			1300-1400	FLEXCOLOR 2700K/4000K/5000K				
LED-7316-FC-G2	32W / 2-PIN CFL	9W	1100	FLEXCOLOR 2700/3000K/3500K/4000/5000K	G24d	↕	6.8" x 2.4"	
LED-7318-FC-G2	32W / 4-PIN CFL				G24q			
LED-7328-FC-G2	42W / 4-PIN CFL				16W			

PART #	REPLACES UP TO	WATTAGE	LUMENS	CCT	BASE	MOUNTING	DIMENSIONS	LISTINGS
PL BALLAST COMPATIBLE TYPE A								
LED-7330-27K-G2	26W / 4-PIN CFL	10W	760	2700K	G24q GX24q	↕	6.8" x 1.3"	
LED-7330-35K-G2			850	3500K				
LED-7330-40K-G2			916	4000K				
LED-7334-27K-G2	32W / 4-PIN CFL	12W	1100	2700K	G24q GX24q	↔	5.8" x 1.4"	
LED-7334-35K-G2				3500K				
LED-7334-40K-G2				4000K				
PL + PLL BALLAST BYPASS TYPE B								
LED-7340-FC-G3	40W / 4-PIN CFL	17W	2024-2228	FLEXCOLOR 3000K/3500K/4000K/5000K/6500K	2G11	↕	22" x 1.7"	
LED-7343-FC-G3	36W / 4-PIN CFL	16W	1900-2000				16" x 1.7"	
LED-7344-FC-G3	24W / 4-PIN CFL	10W	1180-1250				12" x 1.7"	
LED-7345-FC-G3	18W / 4-PIN CFL	8.5W	930-980				8.5" x 1.7"	

LINEAR T8 + T5 RETROFITS

PART #	REPLACES	WATTAGE	LUMENS	CCT	BASE	DIMENSIONS	LISTINGS
T8 BALLAST COMPATIBLE + BALLAST BYPASS TYPE A+B							
LED-10T8-FCAB24-G4	17W	10W	1450	FLEXCOLOR 3000K/3500K/ 4000K 5000K/6500K	G13	24.0" x 1.0"	
LED-11T8-FCAB36-G4	25W	11W	1650			36.0" x 1.0"	
LED-12T8-FCAB48-G4	32W	12W	1800			48.0" x 1.0"	
LED-15T8-FCAB48-G4		15W	2200				

DEFAULT CCT FOR FLEXCOLOR IS SHOWN IN BOLD.

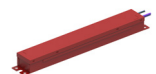

OPTIONAL EMERGENCY BATTERY BACKUP (SOLD SEPARATELY)

T8 BALLAST BYPASS TYPE B							
LED-9T8-840DE24-G3	17W	9W	1150	4000K	G13	24.0" x 1.0"	
LED-12T8-840DE36-G3	25W	12W	1450			36.0" x 1.0"	
LED-12T8-840DE48-G3	32W		1800			48.0" x 1.0"	
LED-42T8-FC-96-G5	86W	42W	5000	FLEXCOLOR 3000K/3500K/ 4000K 5000K/6500K	FA8	93.0" x 1.0"	

T5 BALLAST COMPATIBLE + BALLAST BYPASS TYPE A+B							
RP-TOTALTUBE-T5-2FT-835-G4	24W	12W	1350	3500K	G5 MINI BI-PIN	24.0" x 1.0"	
RP-TOTALTUBE-T5-2FT-840-G4			1500	4000K			
RP-TOTALTUBE-T5-2FT-850-G4			5000K				
RP-TOTALTUBE-T5-3FT-835-G4	39W	18W	2025	3500K	G5 MINI BI-PIN	36.0" x 1.0"	
RP-TOTALTUBE-T5-3FT-840-G4			2250	4000K			
RP-TOTALTUBE-T5-3FT-850-G4			5000K				
RP-TOTALTUBE-T5-4FT-835-G4	54W	24W	3200	3500K	G5 MINI BI-PIN	48.0" x 1.0"	
RP-TOTALTUBE-T5-4FT-840-G4			3500	4000K			
RP-TOTALTUBE-T5-4FT-850-G4			5000K				

ENERGY SAVING REPLACEMENTS FOR FLUORESCENT T8, T5 AND U-BEND LAMPS. Every size and installation method you need — in the highest quality, best light output design. Install our retrofits to get worry-free operation for years to come.



LED-10T8-FCA

ENERGY SAVING REPLACEMENTS FOR ANY FACILITY

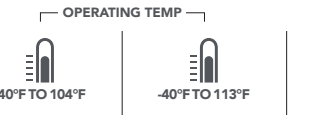
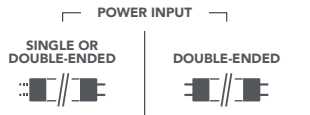
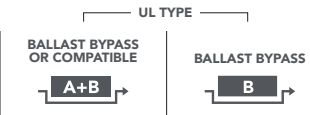
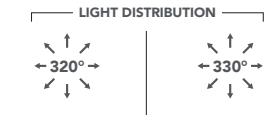



WORK LIGHTS



4 MODELS REPLACING UP TO 400W HID. Super bright and durable, our LED work site lights reduce costs and labor with integrated power cord and daisy-chain feature. Several wattages and connection options to choose from will make lighting any work site easier than ever.

PART #	VOLTAGE	PWR CORD	DAISY-CHAIN	REPLACES	WATTAGE	LUMENS	CCT	DIMENSIONS	LISTINGS
TEMPORARY WORK SITE LIGHTS									
LED-9006-50K	120V	20 FT POWER CORD	UP TO 10 LIGHTS	250W HID	60W	6600	5000K	6.2" x 10.7"	
LED-9010-50K	120V	35 FT POWER CORD	UP TO 6 LIGHTS	400W HID	100W	11000		6.2" x 12.2"	
LED-9011-50K-G2	120V	35 FT POWER CORD	UP TO 10 LIGHTS						
HIGH BAY WORK SITE LIGHTS BALLAST BYPASS TYPE B									
LED-9210-50K-G2	120-277V*	6 FT POWER CORD W/ STRIPPED LEADS	NA	400W HID	100W	12000	5000K	6.5" x 12.7"	
* UL LISTED FOR 120-277VAC. ALSO WORKS ON 208V & 240V.									
TEMPORARY WORK SITE STRING LIGHTS									
LED-9003-50K-10PK-163-G3	120V	100 FT STRING	UP TO 5 STRINGS	900W INC	120W (10 X 12W)	15000/STRING	5000K	4.4" x 3.1"	
LED-9003-50K-10PK-182-G3			UP TO 4 STRINGS		130W (10 X 13W)	16000/STRING			



← LED-9010

35 FT POWER CORD



↗ LED-9003-182

CONNECT UP TO 4 STRINGS / 400 FT

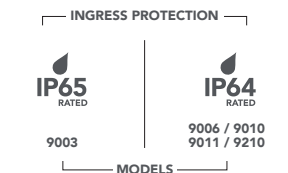
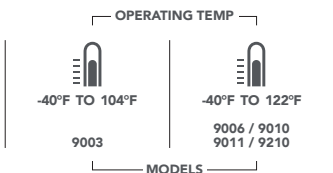

REMOTE CONTROL INCLUDED 2-PRONG PLUG (NEMA 1-15P) 3-PRONG PLUG (NEMA 5-15P / GROUNDED OUTLET) FOR USE IN CANADA ONLY FOR USE IN USA ONLY

* 9003 MODELS HAVE A 3 YEAR WARRANTY. ** 9210 IS UL LISTED FOR 120-277VAC, 9210 ALSO WORKS ON 208V & 240V. ALL OTHER MODELS ARE 120V. *** EXCLUDES MODEL 9210. LIGHT EFFICIENT DESIGN / WORK LIGHTS

RemPhos

rem·phos /rem·fäs/ noun

1. Innovatively engineered LED fixtures and retrofits making installation as fast & easy as possible. **2.** Controllable & customizable LED fixtures and retrofits that maximize the lighting experience for end users. **3.** Brand name derived from a remote layer of phosphor necessary to convert blue LED light to white.



SIMPLE LIGHTING CONTROLS

Looking to add some basic control capability to specific luminaires, and don't need an elaborate networked system? You're in the right place. RemPhos SIMPLE control components are the easiest way to make a luminaire smart.



NETWORKED LIGHTING CONTROLS

Looking to add high value control capabilities at the room, building, or even campus levels? Then you want a RemPhos NETWORKED control system. NETWORKED controls deliver the most control function capabilities and the greatest energy savings.

SILVAIR BLUETOOTH MESH is a leading Networked Lighting Control (NLC) option. The Silvair system and software combine high functionality with ease of use, providing a great overall NLC solution.

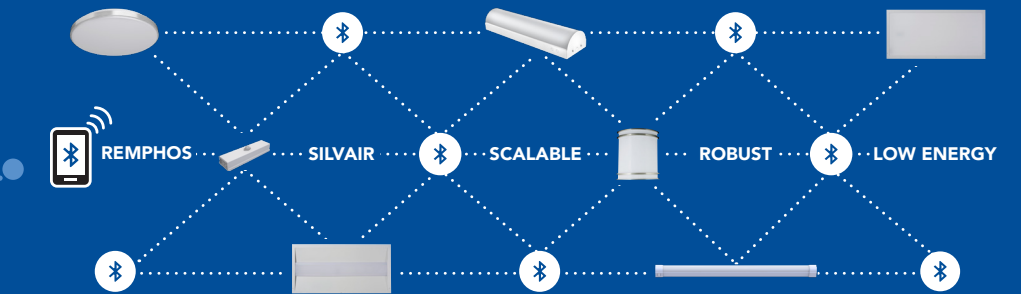

USE THE SILVAIR COMMISSIONING APP TO CONNECT AND CONTROL LIGHTING FIXTURES USING BLUETOOTH MESH TECHNOLOGY. COMPATIBLE WITH IOS AND ANDROID DEVICES, DOWNLOAD ON THE APP STORE OR GOOGLE PLAY.



YOU HAVE A CHOICE BETWEEN SIMPLICITY OR HIGH-CAPABILITY SYSTEMS...

ONE LIGHT. UNLIMITED POSSIBILITIES...CONNECT UP TO 40 FROM ONE POWER FEED*

SIMPLE LIGHTING CONTROLS

RP-LBI-OC2-A
IN-LINE MICROWAVE AND DAYLIGHT HARVESTING OCCUPANCY SENSOR

RP-LBI-PIR-A
IN-LINE PASSIVE INFRARED OCCUPANCY SENSOR

NETWORKED LIGHTING CONTROLS

RP-LBI-BLE-A
IN-LINE SILVAIR-READY BLUETOOTH CONTROL NODE

RP-LBI-BLE-PIR-A
IN-LINE SILVAIR-READY BLUETOOTH CONTROL NODE W/ PASSIVE INFRARED OCCUPANCY SENSOR

RP-LBI-BLE-OC
IN-LINE SILVAIR-READY BLUETOOTH MICROWAVE OCCUPANCY SENSOR

*USE THE SILVAIR APP TO ADJUST CONTROL SETTINGS



OPTIONAL REMOTE EMERGENCY BATTERY BACK UP*			REMOTE CONTROL				
RP-LBI-EMG2-8W-DIM (8W / DIMMABLE)		RP-LBI-EMG2-25W-DIM (25W / DIMMABLE)		RP-LBI-EMG2-25W (25W / NON DIMMABLE)		RC-REMOTE-IR11 (FOR OCCUPANCY SENSORS)	
PART #	WATTAGE	LUMENS	CCT	DIMENSIONS	LISTINGS		
LBI – LINKABLE BAR / INTERNAL DRIVER							
RP-LBI-G1-2F-6W-27K-WC2	FLEXWATT 6W/9W/12W	696-1524	FLEXCOLOR 2700K/3000K/3500K	19.3" x 1.2" x 1.2"			
RP-LBI-G1-2F-6W-40K-WC		780-1560	FLEXCOLOR 3000K/4000K/5000K				
RP-LBI-G1-3F-10W-27K-WC2	FLEXWATT 10W/12W/15W	1270-1980	FLEXCOLOR 2700K/3000K/3500K	31.3" x 1.2" x 1.2"			
RP-LBI-G1-3F-10W-40K-WC		1400-2100	FLEXCOLOR 3000K/4000K/5000K				
RP-LBI-G1-4F-15W-27K-WC2	FLEXWATT 10W/15W/25W	1260-3400	FLEXCOLOR 2700K/3000K/3500K	43.3" x 1.2" x 1.2"			
RP-LBI-G1-4F-15W-40K-WC		1462-3653	FLEXCOLOR 3000K/4000K/5000K				

DEFAULT WATTAGE AND CCT ARE SHOWN IN BOLD.

SWITCH BETWEEN WATT & COLOR TEMPS, SO MANY ACCESSORIES...

MOUNTING ACCESSORIES

INCOMING POWER

CONNECTORS

SEE SPEC SHEET FOR FULL LINE OF ACCESSORIES

>0.9 PWR FACTOR/THD icon"/>

>100,000hrs RATED LIFE** icon"/>

* CONNECT UP TO 33 4FT UNITS TOGETHER @ 120VAC OR 40 4FT UNITS @ 277VAC. ** CALCULATED.





LINKABLE BAR / INTERNAL DRIVER IP65 (LBI65)



CONTROL CAPABILITIES AT THE ROOM, BUILDING, OR EVEN CAMPUS LEVELS...

WATERPROOF LINKING – NO TOOLS NEEDED...CONNECT UP TO 40 FROM ONE POWER FEED*

SIMPLE LIGHTING CONTROLS

RP-LBI65-PIR-A
IP65 IN-LINE PASSIVE INFRARED OCCUPANCY SENSOR

NETWORKED LIGHTING CONTROLS

RP-LBI65-BLE-A
IP65 IN-LINE SILVAIR-READY BLUETOOTH CONTROL NODE

RP-LBI65-BLE-PIR-A
IP65 IN-LINE SILVAIR-READY BLUETOOTH CONTROL NODE W/ PASSIVE INFRARED OCCUPANCY SENSOR



*USE THE SILVAIR APP TO ADJUST CONTROL SETTINGS



REMOTE CONTROL
WATTAGE & CCT ADJUSTING REMOTE INCLUDED W/ EACH LBI65 BAR



OPTIONAL REMOTE EMERGENCY BATTERY BACK UP*

REMOTE CONTROL

PART #	WATTAGE	LUMENS	CCT	DIMENSIONS	LISTINGS
RP-LBI-EMG2-8W-DIM (8W / DIMMABLE)	RP-LBI-EMG2-25W-DIM (25W / DIMMABLE)	RP-LBI-EMG2-25W (25W / NON DIMMABLE)	RC-REMOTE-IR11 (FOR PASSIVE INFRARED OCCUPANCY SENSOR)		
LBI 65 – LINKABLE BAR / INTERNAL DRIVER IP65					
RP-LBI65-2F-6W-40K-WC	FLEXWATT 4W/ 6W /9W/12W	640-1920	FLEXCOLOR 2700K, 3000K, 3500K, 4000K , 5000K, 5700K	19.3" x 1.5" x 1.5"	 (PENDING)
RP-LBI65-3F-10W-40K-WC	FLEXWATT 6W/ 10W /12W/15W	960-2400		31.3" x 1.5" x 1.5"	
RP-LBI65-4F-25W-40K-WC	FLEXWATT 10W/15W/20W/ 25W	1920- 4000		43.3" x 1.5" x 1.5"	

DEFAULT WATTAGE AND CCT ARE SHOWN IN BOLD.

SWITCH BETWEEN WATT & COLOR TEMPS, SO MANY ACCESSORIES...

AIRCRAFT SUSPENSION CABLE

10 FT / STAINLESS STEEL + WATERPROOF

INCOMING POWER

3 FT CABLE WIRE WHIP CONDUIT ADAPTER

CONNECTORS

UP TO 48 IN LINKING CABLE DIMMABLE W/CCT SEAMLESS CONNECTORS NON-DIMMABLE

SEE SPEC SHEET FOR FULL LINE OF ACCESSORIES

>100,000hrs RATED LIFE (CALCULATED) icon"/>



FOR LISTING STATUS GO TO LED-LLC.COM

* EMERGENCY BATTERY BACKUP IS FOR INDOOR USE ONLY.

* CONNECT UP TO 33 4FT UNITS TOGETHER @ 120VAC OR 40 4FT UNITS @ 277VAC. **PENDING.

REMPHOS / FIXTURES + RETROFIT KITS



THE EASIEST WAY TO MAKE A LUMINAIRE SMART...

SIMPLE LIGHTING CONTROLS



-OCC

MICROWAVE AND DAYLIGHT HARVESTING OCCUPANCY SENSOR

NETWORKED LIGHTING CONTROLS



-BT

SILVAIR-READY BLUETOOTH NODE W/ EXTERNAL ANTENNA



-OCBT

SILVAIR-READY BLUETOOTH MICROWAVE OCCUPANCY SENSOR



*USE THE SILVAIR APP TO ADJUST CONTROL SETTINGS

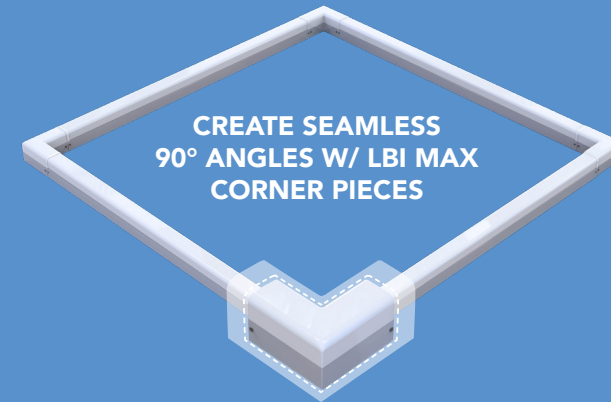

CREATE SEAMLESS 90° ANGLES W/ LBI MAX CORNER PIECES

HIGHER LUMEN – LINKABLE FIXTURE...CONNECT UP TO 40 FROM ONE POWER FEED*

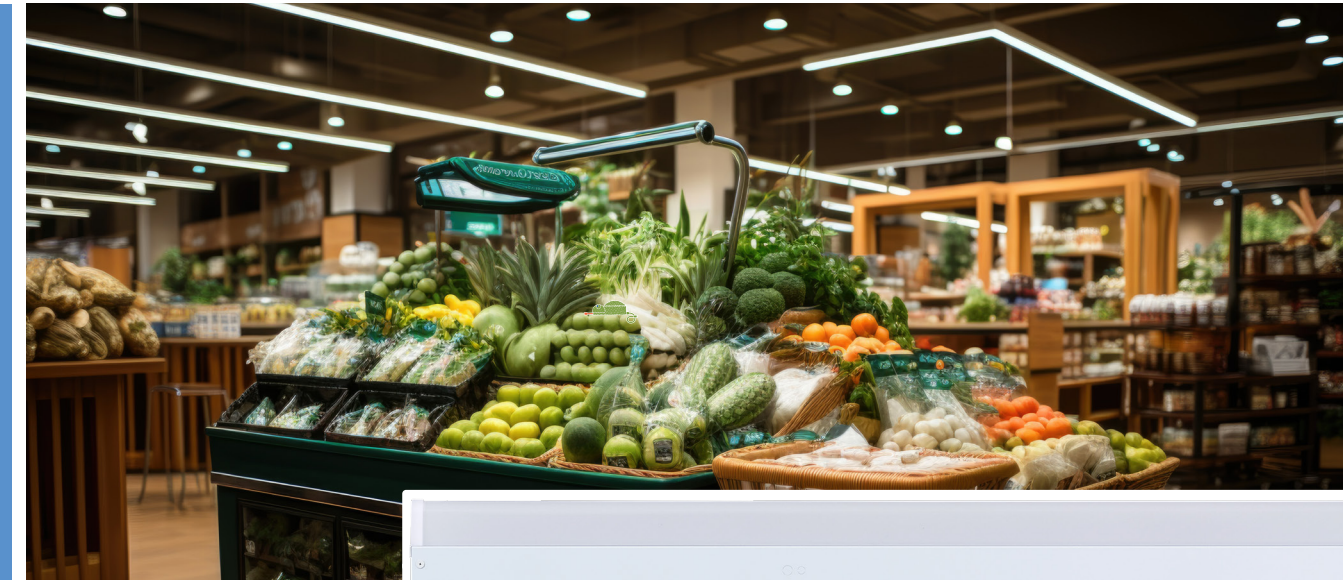

OPTIONAL INTERNAL EMERGENCY BATTERY BACK UP

-EM1 / EMERGENCY BATTERY BACKUP (90 MIN / 500 LM)

REMOTE CONTROL

RC-REMOTE-IR12 (FOR MICROWAVE OCC SENSORS)

PART #	WATTAGE	LUMENS	CCT	DIMENSIONS	LISTINGS
LBI MAX – LINKABLE STRIP FIXTURE					
RP-LBIMAX-2F-25W-40K-WC	FLEXWATT / 15W/20W/ 25W /30W	1950-3900	FLEXCOLOR 3000K/3500K/ 4000K /5000K	24" x 2.5" x 3.0"	
RP-LBIMAX-4F-48W-40K-WC	FLEXWATT / 30W/35W/ 40W /48W	3997-6365		48" x 2.5" x 3.0"	
RP-LBIMAX-LR-16W-40K-WC (CORNER RIGHT)	FLEXWATT / 7W/10W/ 13W /16W	910-2080		6" x 2.5" x 3.0"	
RP-LBIMAX-LL-16W-40K-WC (CORNER LEFT)					

DEFAULT WATTAGE AND CCT ARE SHOWN IN BOLD.

SWITCH BETWEEN WATT & COLOR TEMPS, SO MANY ACCESSORIES...

MOUNTING ACCESSORIES

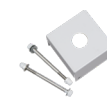

PENDANT MOUNT KIT



SUSPENSION MOUNT LINKING BRACKET KIT

INCOMING POWER



3 FT CABLE KIT



CABLE W/ SWITCH



90° CABLE

CONNECTORS



LINKING CABLE



DIMMABLE



NON-DIMMABLE

...SEAMLESS CONNECTORS...



SEE SPEC SHEET FOR FULL LINE OF ACCESSORIES

- 120-277V
- 0-10V DIM TO OFF
- 12V AUX OUTPUT
- OPTIONAL NETWORK LIGHTING CONTROL
- OPTIONAL SIMPLE OCC
- OPTIONAL EMG BATTERY BACKUP
- 1146 LPW EFFICACY (LIGHT ENGINE)
- 80+ CRI
- 120° BEAM ANGLE
- 4°F TO 113°F OPERATING TEMP
- >100,000hrs RATED LIFE (CALCULATED) icon"/> >100,000hrs RATED LIFE (CALCULATED)
- 51,000hrs RATED LIFE

* CONNECT UP TO 20 4 FT UNITS TOGETHER @ 120VAC OR 40 4FT UNITS @ 277VAC.

REMPHOS / FIXTURES



FOR LISTING STATUS GO TO LED-LLC.COM



YOU HAVE A CHOICE BETWEEN SIMPLICITY OR HIGH-CAPABILITY SYSTEMS...

FROM WIDE FOOTPRINTS TO ULTRA-SLIM, HIGH PERFORMANCE STRIPS...

SIMPLE LIGHTING CONTROLS



-OCC

MICROWAVE AND DAYLIGHT HARVESTING OCCUPANCY SENSOR

NETWORKED LIGHTING CONTROLS



-BT

SILVAIR-READY BLUETOOTH NODE W/ EXTERNAL ANTENNA



-OCBT

SILVAIR-READY BLUETOOTH MICROWAVE OCCUPANCY SENSOR



*USE THE SILVAIR APP TO ADJUST CONTROL SETTINGS

EASILY ACCESSORIZE THE LIVC TO FIT YOUR STYLE

OPTIONAL END CAPS

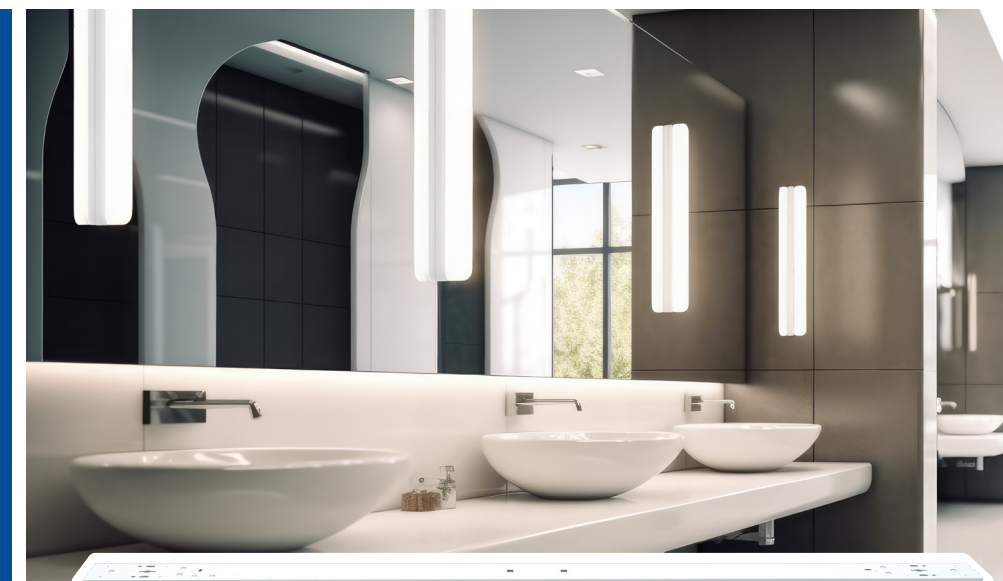
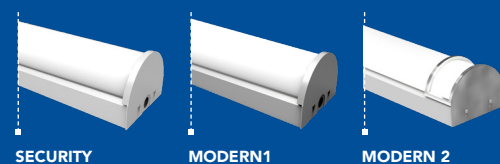

LS-LINEAR STRIP



LIVC

OPTIONAL INTERNAL EMERGENCY BATTERY BACK UP

REMOTE CONTROL

-EMG / EMERGENCY BATTERY BACKUP (90 MIN / 500 LM)

RC-REMOTE-IR12 (FOR MICROWAVE OCC SENSORS)

PART #	WATTAGE	LUMENS	CCT	DIMENSIONS	LISTINGS
LINEAR STRIP					
RP-B-LS-G2-2FT-25W-40K-WC	FLEXWATT / 10W/15W/25W	1950-3250	FLEXCOLOR 3000K/4000K/5000K	24.0" x 3.0" x 3.3"	
RP-B-LS-G2-4FT-30W-40K-WC	FLEXWATT / 25W/30W/40W	3250-5200		48.0" x 3.0" x 3.3"	
LIVC – STAIRWELL / VANITY					
RPT-P-LIVC-G2-2FT-20L-840-FWFC-R-S1	FLEXWATT / 10W/15W/20W/30W	1240-3750	FLEXCOLOR 3000K/3500K/4000K	23" x 6.0" x 4.2"	
RPT-P-LIVC-G2-3FT-20L-840-FWFC-R-S1				34" x 6.0" x 4.2"	
RPT-P-LIVC-G2-4FT-20L-840-FWFC-R-S1				46" x 6.0" x 4.2"	

DEFAULT WATTAGE AND CCT ARE SHOWN IN BOLD.

ACCESSORIES (FOR LIVC – STAIRWELL / VANITY)

RPT-P-LIVC-G2-ENDCAP-SECURITY1	2X TAMPER RESISTANT END CAPS
RPT-P-LIVC-G2-ENDCAP-MODERN1	2X SINGLE BAR BRUSHED NICKEL END CAPS
RPT-P-LIVC-G2-ENDCAP-MODERN2	2X DOUBLE BAR BRUSHED NICKEL END CAPS
RPT-P-LIVC-G2-JUNCTION-WHT	JUNCTION BRACKET FOR CONTINUOUS RUNS

ADD A PULL CHAIN FEATURE...



SCAN FOR FULL LINE OF PRODUCT OFFERINGS

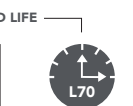
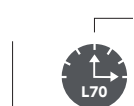



CONTROL CAPABILITIES AT THE ROOM, BUILDING, OR EVEN CAMPUS LEVELS...

SIMPLE LIGHTING CONTROLS*

-OC1
MICROWAVE AND DAYLIGHT HARVESTING OCCUPANCY SENSOR

-OCLR
LIMITED-RANGE MICROWAVE AND DAYLIGHT HARVESTING OCCUPANCY SENSOR (NO MOUNTING FEET)

NETWORKED LIGHTING CONTROLS*

-BT
SILVAIR-READY BLUETOOTH CONTROL NODE

-OCBT
SILVAIR-READY BLUETOOTH MICROWAVE AND DAYLIGHT HARVESTING OCCUPANCY SENSOR

-BTX
SILVAIR-READY BLUETOOTH CONTROL NODE W/ EXTERNAL ANTENNA

* USE THE SILVAIR APP TO ADJUST CONTROL SETTINGS

OUR DRUM AND SCONCE FIXTURES ARE POWERED BY THE LEDCR/SR ...

DRUM AND SCONCE FIXTURES IN SEVERAL SIZES & DESIGNS...



OPTIONAL FIELD INSTALLABLE EMERGENCY BACKUP*		REMOTE CONTROL			
-EMG / EMERGENCY BATTERY BACKUP (90 MIN / 500 LM)		RC-REMOTE-IR12 (FOR MICROWAVE OCC SENSORS)			
PART #	WATTAGE	LUMENS	CCT	DIMENSIONS	LISTINGS
UTILITY DRUMS					
RP-DRU-11N-14L-40K-WC-G2-A	FLEXWATT / 6W/10W/16W/22W	780-3124	FLEXCOLOR / 3000K/3500K/4000K	11.0" x 3.5"	
RP-DRU-14N-14L-40K-WC-G2-A				14.0" x 3.5"	
DESIGNER DRUMS					
RP-DRD-14N-14L-40K-WC-G2-A	FLEXWATT / 6W/10W/16W/22W	780-3124	FLEXCOLOR / 3000K/3500K/4000K	14.5" x 3.5"	
RP-DRD-18N-14L-40K-WC-G2-A				18.0" x 3.5"	
OUTDOOR DRUM					
RP-DRO-12N-14L-40K-WC-G2	FLEXWATT / 6W/10W/16W/22W	780-3124	FLEXCOLOR / 3000K/3500K/4000K	12.0" x 4.0"	
TOUGH DRUM					
RP-DRT-13N-14L-40K-WC-G2	FLEXWATT / 6W/10W/16W/22W	780-3124	FLEXCOLOR / 3000K/3500K/4000K	13.0" x 3.8"	

DEFAULT WATTAGE AND CCT ARE SHOWN IN BOLD.

PART #	WATTAGE	LUMENS	CCT	DIMENSIONS	LISTINGS
SCONCE					
RP-SCD-11N-8L-40K-WC-G2	FLEXWATT / 6W/10W/12W/15W	780-3125	FLEXCOLOR / 3000K/3500K/4000K	13.0" x 3.8"	



120-277V

0-10V DIM TO OFF

12V AUX OUTPUT

OPTIONAL NETWORK LIGHTING CONTROL

OPTIONAL SIMPLE OCC

OPTIONAL EMG BATTERY BACKUP

120° BEAM ANGLE

80+ CRI

4°F TO 140°F OPERATING TEMP

100,000hrs RATED LIFE



THE EASIEST WAY TO MAKE A LUMINAIRE SMART...

SIMPLE LIGHTING CONTROLS*

-OCC
MICROWAVE AND DAYLIGHT HARVESTING OCCUPANCY SENSOR

-OCLR
LIMITED-RANGE MICROWAVE AND DAYLIGHT HARVESTING OCCUPANCY SENSOR (NO MOUNTING FEET)

NETWORKED LIGHTING CONTROLS*

-BT
SILVAIR-READY BLUETOOTH CONTROL NODE

-OCBT
SILVAIR-READY BLUETOOTH MICROWAVE AND DAYLIGHT HARVESTING OCCUPANCY SENSOR

-BTX
SILVAIR-READY BLUETOOTH CONTROL NODE W/ EXTERNAL ANTENNA

* USE THE SILVAIR APP TO ADJUST CONTROL SETTINGS

EXPANDABLE LED PANELS...

(LEDSR-4IN + LEDCR-9IN ONLY)

KEEP YOUR EXISTING FIXTURE AND FUTURE-PROOF IT...



EMG OPTIONAL FIELD INSTALLABLE EMERGENCY BACKUP (SHIPS SEPARATELY)		REMOTE CONTROL			
-EMG / EMERGENCY BATTERY BACKUP (90 MIN / 500 LM)		RC-REMOTE-IR12 (FOR MICROWAVE OCC SENSORS)			
PART #	WATTAGE	LUMENS	CCT	DIMENSIONS	LISTINGS
LEDCR – CIRCULAR RETROFIT KIT					
RPT-P-LEDCR-G2-9IN-14L-840-FWFC	FLEXWATT 6W/10W/16W/22W	780-3124	FLEXCOLOR 3000K/3500K/4000K	8.7" x 8.7" x 2.0"	
LEDSR – SCONCE RETROFIT KITS					
RPT-P-LEDSR-G2-4IN-8L-840-FWFC	FLEXWATT 6W/10W/12W/15W	780-2130	FLEXCOLOR 3000K/3500K/4000K	6.5" x 7.0" x 2.1"	
RPT-P-LEDSR-G2-9IN-8L-840-FWFC				8.7" x 4.5" x 2.0"	
RPT-P-LEDSR-G2-14INE-8L-840-FWFC				14.0" x 2.7" x 2.1"	
RPT-P-LEDSR-G2-14INM-8L-840-FWFC					

DEFAULT WATTAGE AND CCT ARE SHOWN IN BOLD.



120-277V
*

0-10V
DIM TO OFF
SENSOR READY

12V
AUX OUTPUT

OPTIONAL NETWORK LIGHTING CONTROL

OPTIONAL SIMPLE OCC

120°
BEAM ANGLE

OPTIONAL EMG BATTERY BACKUP

80+
CRI

-4°F TO 140°F
OPERATING TEMP

L70
100,000hrs
RATED LIFE

* ALSO WORKS ON 208V & 240V.

REMPHOS / RETROFIT KITS



FOR LISTING STATUS GO TO LED-LLC.COM



LINEAR BARKITS / EXTERNAL DRIVER (LBE) + TYPE C T5 & T8 KITS



YOU HAVE A CHOICE BETWEEN SIMPLICITY OR HIGH-CAPABILITY SYSTEMS...

TRADITIONAL LOOK OF FLUORESCENT TUBES OR HIGHER EFFICIENCY OF A BARKIT...

SIMPLE LIGHTING CONTROLS

RC-OCC-HNS-111-A
MICROWAVE AND DAYLIGHT HARVESTING OCCUPANCY SENSOR

RC-OCLR-HNS111LR-A
LIMITED-RANGE MICROWAVE AND DAYLIGHT HARVESTING OCCUPANCY SENSOR (NO MOUNTING FEET)

NETWORKED LIGHTING CONTROLS*

RC-BT-HNB131CTL
SILVAIR-READY BLUETOOTH CONTROL NODE

RC-BTX-HNB136
SILVAIR-READY BLUETOOTH NODE W/ EXTERNAL ANTENNA

RC-OCBT-HNB115MW
SILVAIR-READY BLUETOOTH MICROWAVE AND DAYLIGHT HARVESTING OCCUPANCY SENSOR

*USE THE SILVAIR APP TO ADJUST CONTROL SETTINGS



OPTIONAL EMG / STAND-ALONE BATTERY BACKUP (SHIPS SEPARATELY)

<p>RP-EM-SK1-500LM/90-3x1.5 90 MINUTE EMG W/ 3 IN X 1.5 IN LED MODULE</p>	<p>RP-EM-SK1-500LM/90-4.7x0.8 90 MINUTE EMG W/ 4.7 IN X 0.8 IN LED MODULE</p>	<p>RP-EM-SK1-500LM/90-1FT 90 MINUTE EMG W/ 10.2 IN X 0.9 IN LED MODULE</p>
--	--	---

BUILD YOUR TYPE C T5 & T8 KITS				BUILD YOUR LBE			
<p>RP-T5C-G2-[WATTAGE]-[LENGTH]-[#LAMPS]-[8+COLOR]-[DIMMING]-[HV*] RP-T8C-G2-[WATTAGE]-[LENGTH]-[#LAMPS]-[8+COLOR]-[DIMMING]-[HV*]</p>				<p>RP-LBE-G2-[WATTAGE]-[LENGTH]-[#LAMPS]-[8+COLOR]-[DIMMING]-[HV*]</p>			
WATTAGE							
12W (6-8-10-12)		25W (15-18-20-25)		45W (30-35-40-45)		80W (50-60-70-80)	
TYPE C LENGTH				LBE LENGTH			
2 FT		3 FT		4 FT		1 FT	
3 FT		4 FT		5 FT		2 FT	
4 FT		5 FT		6 FT		3 FT	
5 FT		6 FT		7 FT		4 FT	
# OF LAMPS		COLOR		STANDARD DIMMING		OPTIONAL DIMMING	
1L 1 LAMP	2L 2 LAMPS	3L 3 LAMPS	4L 4 LAMPS	30 (3000K)	35 (3500K)	40 (4000K)	50 (5000K)
				10V 0-10V DIM		LVD 120-277V TRIAC	
				1 STEP SINGLE SWITCH		2 STEP 2 SWITCH	

10 YEAR WARRANTY

120-277V | 120-347V *

0-10V DIM TO OFF
SENSOR READY

12V AUX OUTPUT

OPTIONAL NETWORK LIGHTING CONTROL

OPTIONAL SIMPLE OCC

OPTIONAL EMG BATTERY BACKUP

1167 LPW EFFICACY (LIGHT ENGINE)

120° BEAM ANGLE

80+ CRI

4°F TO 122°F OPERATING TEMP

100,000hrs RATED LIFE



TAA LINEAR BARKITS / EXTERNAL DRIVER (LBE) + TYPE C T5 & T8 KITS



CONTROL CAPABILITIES AT THE ROOM, BUILDING, OR EVEN CAMPUS LEVELS...

SIMPLE LIGHTING CONTROLS

-OCC
MICROWAVE AND DAYLIGHT HARVESTING OCCUPANCY SENSOR

-OCLR
LIMITED-RANGE MICROWAVE AND DAYLIGHT HARVESTING OCCUPANCY SENSOR (NO MOUNTING FEET)

NETWORKED LIGHTING CONTROLS*

-BT
SILVAIR-READY BLUETOOTH CONTROL NODE

-OCBT
SILVAIR-READY BLUETOOTH MICROWAVE AND DAYLIGHT HARVESTING OCCUPANCY SENSOR

-ARM-OCCBT-BTX
SILVAIR-READY BLUETOOTH PASSIVE INFRARED EXTERNAL ARM SENSOR

*USE THE SILVAIR APP TO ADJUST CONTROL SETTINGS

TAA

THESE PRODUCTS MEET THE REQUIREMENTS OF THE UNITED STATES TRADE AGREEMENTS ACT (TAA)

SOLUTIONS THAT MEET THE REQUIREMENTS OF THE UNITED STATES TRADE AGREEMENT ACT...



EMG OPTIONAL FIELD INSTALLABLE EMERGENCY BACK UP (SHIPS SEPARATELY)

EMG ADDERS / 4W / 500LM @ 90 MIN / 5000K		EMG ADDERS / 8W / 1000LM @ 90 MIN / 5000K		
-EM1 4.7 IN X 8 IN LED MODULE	-EM2 3 IN X 8 IN LED MODULE	-EM4 1 FT LED MODULE	-EM8 1 FT LED MODULE	-EM9 4.7 IN X 8 IN LED MODULE

120-277V | 120-347V *

0-10V DIM TO OFF
SENSOR READY

12V AUX OUTPUT

OPTIONAL NETWORK LIGHTING CONTROL

OPTIONAL SIMPLE OCC

OPTIONAL EMG BATTERY BACKUP

1167 LPW EFFICACY (LIGHT ENGINE)

120° BEAM ANGLE

80+ CRI

-4°F TO 122°F OPERATING TEMP

L70 100,000hrs RATED LIFE

BUILD YOUR TAA LBE				BUILD YOUR TAA TYPE C T5 & T8 KITS			
RP-LBE-G2-[WATTAGE]-[FT]-[#LAMPS]-[8+COLOR]-[DIMMING]-[CONTROLS]-[EM#]-[TAA]				RP-T5C-G2-[WATTAGE]-[FT]-[#LAMPS]-[8+COLOR]-[DIMMING]-[CONTROLS]-[EM#]-[TAA] RP-T8C-G2-[WATTAGE]-[FT]-[#LAMPS]-[8+COLOR]-[DIMMING]-[CONTROLS]-[EM#]-[TAA]			
12W (6-8-10-12)		25W (15-18-20-25)		45W (30-35-40-45)		80W (50-60-70-80)	
CHOOSE YOUR LBE LENGTH				CHOOSE YOUR TYPE C LENGTH			
2 FT		3 FT		4 FT		2 FT	
3 FT		4 FT		2 FT		3 FT	
4 FT		2 FT		3 FT		4 FT	
# OF LAMPS				COLOR			
IL 1 LAMP	2L 2 LAMPS	3L 3 LAMPS	4L 4 LAMPS	30 (3000K)	35 (3500K)	40 (4000K)	50 (5000K)
STANDARD DIMMING				OPTIONAL DIMMING			
10V 0-10V DIM				LVD 120-277V TRIAC		1 STEP SINGLE SWITCH	
2 STEP 2 SWITCH				OPTIONAL FIELD INSTALLABLE EMERGENCY BACK UP (SEE PG 18)			





THE EASIEST WAY TO MAKE A LUMINAIRE SMART...

SIMPLE LIGHTING CONTROLS



-OCC

PASSIVE INFRARED
AND DAYLIGHT HARVESTING
OCCUPANCY SENSOR

NETWORKED LIGHTING CONTROLS



-BT

SILVAIR-READY
BLUETOOTH
CONTROL NODE



-OCCBT

SILVAIR-READY
PASSIVE INFRARED AND
DAYLIGHT HARVESTING
OCCUPANCY SENSOR



*USE THE SILVAIR APP TO ADJUST CONTROL SETTINGS

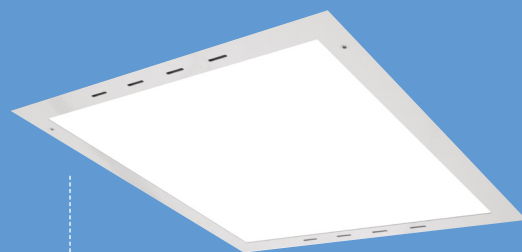

NEED AIR RETURN...
ADD -AIR TO PART NUMBER
WHEN ORDERING

USE AS A RETROFIT KIT OR A FIXTURE — ONE PIECE DESIGN — 2X FASTER INSTALL...



OPTIONAL INTERNAL EMERGENCY BATTERY BACK UP

-EMG / EMERGENCY BATTERY BACKUP (90 MIN / 500 LM)

REMOTE CONTROL

RC-REMOTE-IR12 (FOR MICROWAVE OCC SENSORS)

PART #	WATTAGE	LUMENS	CCT	DIMENSIONS	LISTINGS
TROFFER RETROFIT KITS & FIXTURES					
RP-TTV-G1-2X2-20L-840-FWFC-SR	FLEXWATT / 16W/20W/24W/28W	2000-3640	FLEXCOLOR 3500K/ 4000K /5000K	23.7" x 23.7" x 1.6"	
RP-TTV-G1-1X4-25L-840-FWFC-SR	FLEXWATT / 16W/20W/24W/28W	1968-3556		11.9" x 47.8" x 1.5"	
RP-TTV-G1-2X4-33L-840-FWFC-SR	FLEXWATT / 20W/26W/34W/40W	2540-5300		23.7" x 47.8" x 1.6"	
RP-TTF-G1-2X2-20L-840-FWFC-SR	FLEXWATT / 16W/20W/24W/28W	2000-3640		23.7" x 23.7" x 1.7"	
RP-TTF-G1-1X4-25L-840-FWFC-SR	FLEXWATT / 16W/20W/24W/28W	1968-3556		11.9" x 47.8" x 1.7"	
RP-TTF-G1-2X4-33L-840-FWFC-SR	FLEXWATT / 20W/26W/34W/40W	2540-5300		23.7" x 47.8" x 1.7"	

DEFAULT WATTAGE AND CCT ARE SHOWN IN BOLD.

ACCESSORIES

PART #	DESCRIPTION	PART #	DESCRIPTION
RPT-LEDPANEL-SMK-2X2	2X2 SURFACE MOUNT KIT	RPT-LEDPANEL-FMK-2X2-A	2X2 FLANGE KIT
RPT-LEDPANEL-SMK-1X4*	1X4 SURFACE MOUNT KIT	RPT-LEDPANEL-FMK-1X4-A	1X4 FLANGE KIT
RPT-LEDPANEL-SMK-2X4	2X4 SURFACE MOUNT KIT	RPT-LEDPANEL-FMK-2X4-A	2X4 FLANGE KIT

* NOT COMPATIBLE W/ 1X4 TTF

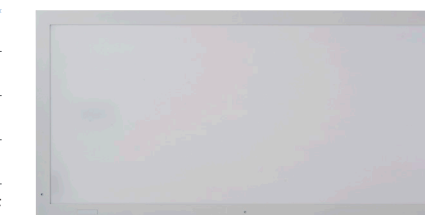

RP-TTF (FLAT PANEL)



RP-TTV (VOLUMETRIC)

-
-
-
-
-
-
-
-
-
-
-
-

* ALSO WORKS ON 208V & 240V.



FOR LISTING STATUS GO TO LED-LLC.COM

REMPHOS / FIXTURES + RETROFIT KITS



TAA TROFFER RETROFIT KITS (TRV/TRF) & FIXTURES (TV/TF)



YOU HAVE A CHOICE BETWEEN SIMPLICITY OR HIGH-CAPABILITY SYSTEMS...

SOLUTIONS THAT MEET THE REQUIREMENTS OF THE UNITED STATES TRADE AGREEMENT ACT...

SIMPLE LIGHTING CONTROLS



-OCC

PASSIVE INFRARED AND DAYLIGHT HARVESTING OCCUPANCY SENSOR

NETWORKED LIGHTING CONTROLS



-OCCBT

SILVAIR-READY PASSIVE INFRARED AND DAYLIGHT HARVESTING OCCUPANCY SENSOR



*USE THE SILVAIR APP TO ADJUST CONTROL SETTINGS

COMING SOON...

TRV-1X4 AND TRF-1X4



RP-TRV (VOLUMETRIC)



RP-TRF (FLAT PANEL)

OPTIONAL INTERNAL EMERGENCY BATTERY BACK UP

REMOTE CONTROL

-EMG1 / EMERGENCY BATTERY BACKUP (90 MIN / 500 LM)

RC-REMOTE-IR12 (FOR MICROWAVE OCC SENSORS)

PART #	WATTAGE	LUMENS	COLOR	DIMENSIONS	LISTINGS
TROFFER FIXTURES					
RP-TV-G1-1X4-35W-40K-WC-TAA	FLEXWATT / 18W/26W/ 35W	2200/3300/ 4400	FLEXCOLOR 3500K/ 4000K /5000K	11.9" x 47.8" x 1.4"	
RP-TV-G1-2X2-35W-40K-WC-TAA				23.7" x 23.7" x 1.4"	
RP-TV-G1-2X4-44W-40K-WC-TAA	FLEXWATT / 26W/35W/ 44W	3300/4400/ 5500		23.7" x 47.8" x 1.4"	
RP-TF-G1-1X4-40W-40K-WC-TAA	FLEXWATT / 20W/30W/ 40W	2600/3900/ 5200		11.9" x 47.8" x 1.4"	
RP-TF-G1-2X2-40W-40K-WC-TAA				23.7" x 23.7" x 1.4"	
RP-TF-G1-2X4-50W-40K-WC-TAA				FLEXWATT / 30W/40W/ 50W	

DEFAULT WATTAGE, LUMENS AND CCT ARE SHOWN IN BOLD.

PART #	WATTAGE	LUMENS	COLOR	DIMENSIONS	LISTINGS
TROFFER RETROFIT KITS					
RP-TRV-2X2-24W-40K-WC-TAA	FLEXWATT / 16W/20W/ 24W	2000/2500/ 3000	FLEXCOLOR 3500K/ 4000K /5000K	22.0" x 21.4" x 1.9"	
RP-TRV-2X4-40W-40K-WC-TAA	FLEXWATT / 24W/30W/ 40W	3000/3750/ 5000		22.0" x 45.4" x 1.9"	
RP-TRF-2X2-24W-40K-WC-TAA	FLEXWATT / 16W/20W/ 24W	2000/2500/ 3000	FLEXCOLOR 3500K/ 4000K /5000K	22.0" x 21.4" x 1.5"	
RP-TRF-2X4-40W-40K-WC-TAA	FLEXWATT / 24W/30W/ 40W	3000/3750/ 5000		22.0" x 45.4" x 1.5"	

DEFAULT WATTAGE, LUMENS AND CCT ARE SHOWN IN BOLD.



* TROFFER RETROFIT KITS HAVE AN EFFICACY OF 125LPW.

REMPHOS / FIXTURES + RETROFIT KITS



FOR LISTING STATUS GO TO LED-LLC.COM



CHOOSE FROM 6 MODELS – HID EQUIVALENCE UP TO 400W...

100% POWERED BY THE SUN – NO TRENCHING OR WIRING...



RP-SAL-8/30W



SCAN FOR POLE OFFERINGS + ACCESSORIES



SL-SAL-60L

OFF-GRID AREA LIGHTS

PART #	COMPARES TO	WATTAGE	LUMENS	CCT	EPA	DIMENSIONS	LISTINGS
RP-SAL-8W-50K-SF-GY-G2	70W HID	8W	1600	5000K	1.82	20.0" x 12.0" x 3.0"	
RP-SAL-8W-50K-SF-DB-G2							
RP-SAL-30W-50K-SF-GY-G2	250W HID	30W	6000	5000K	4.79	36.0" x 16.8" x 3.8"	
RP-SAL-30W-50K-SF-DB-G2							
● RP-SAL-8W-AMB-SF-GY-G2	70W HID	8W	284	580nm AMBER	1.82	20.0" x 12.0" x 3.0"	
● RP-SAL-8W-AMB-SF-DB-G2							
● RP-SAL-30W-AMB-SF-GY-G2	250W HID	30W	806	580nm AMBER	4.79	36.0" x 16.8" x 3.8"	
● RP-SAL-8W-AMB-SF-DB-G2							

OPERATING MODES | TIMER | MOTION SENSING

TURTLE FRIENDLY ● GRAY ● DARK BRONZE FOR LISTING STATUS GO TO LED-LLC.COM

OFF-GRID AREA LIGHTS

PART #	COMPARES TO	WATTAGE	LUMENS	CCT	EPA	DIMENSIONS	LISTINGS
SL-SAL-60L-FC-T3-BK-G3	250W HID	30W	6000	FLEXCOLOR 3000K/4000K/5000K	4.5	36.0" X 26.0" X 32.0"	coming soon
SL-SAL-OG-50W-50K-SF-BK-G2*	400W HID	50W	9800	5000K	6.1	11.2" x 7.0" x 16.3" (FIXTURE) 31.8" x 31.5" (SOLAR PANEL)	

OPERATING MODES | TIMER | MOTION SENSING

CERTIFIED BATTERY

BATTERY CHARGING TIME

RP-SAL

BATTERY CHARGING TEMP

SL-SAL

BATTERY LIFE

RP-SAL

BATTERY LIFE

SL-SAL

BATTERY LIFE

BATTERY LIFE

REPLACEABLE BATTERY

FIXTURE OPERATING TEMP

RP-SAL

FIXTURE OPERATING TEMP

SL-SAL

MOTION SENSING

100,000hrs RATED LIFE

EXCLUSIVE LONG-LASTING BATTERY FOR LISTING STATUS GO TO LED-LLC.COM * WHILE SUPPLIES LAST.

INTELLIGENT MODULAR AREA LIGHT

PROFESSIONAL-GRADE, CONFIGURABLE, SOLAR-POWERED LIGHTING SYSTEM...



i-SERIES

- ... ACCESS SOLERA CONNECT VIA THE WEB OR MOBILE APP
- ... MONITOR LIGHT LEVELS THROUGHOUT THE DAY
- ... MAP YOUR PROJECTS













EXAMPLE OF CUSTOMER DASHBOARD

INTELLIGENT MODULAR AREA LIGHT

PART #	LUMENS	CCT	EPA	DIMENSIONS
SL-MA1-OG-1000634B1	ADJUSTABLE UP TO 10,000	FLEXCOLOR 3000K/4000K/5000K	8.0	SOLAR PANEL 27.1" x 19.2" x 2.2"
SL-MA1-HYB-1000634B1				

OPERATING MODES |  CONSTANT BRIGHTNESS  MOTION SENSING

 **HYBRID | POWERED BY THE SUN & BACKED UP BY LINE-VOLTAGE**  **OFF-GRID | 100% POWERED BY THE SUN**

-  STANDARD
-  OPTIONAL*
-  CERTIFIED BATTERY
-  BATTERY CHARGE TIME
-  FULL POWER ALL NIGHT**
-  BATTERY CHARGE TEMP
-  BATTERY LIFE**
-  REPLACEABLE BATTERY
-  -40°F TO 140°F FIXTURE OPERATING TEMP
-  OPTIONAL MOTION SENSING
-  100,000hrs RATED LIFE

* 10 YEAR WARRANTY AVAILABLE AT AN ADDITIONAL COST. **BATTERY LIFE DEPENDS ON ENVIRONMENT AND POWER SETTINGS

BUILD AND REMOTELY PROGRAM, CONTROL AND MONITOR AN INTELLIGENT SOLAR LIGHTING NETWORK. GRAPHICALLY SHOW USAGE AND DEMAND. TRACK SOLAR ENERGY GENERATION FOR SUSTAINABILITY REPORTING AND POSSIBLE TAX CREDITS.

CONFIGURE THE INTELLIGENT MODULAR AREA LIGHT TO FIT YOUR APPLICATION Area lighting, pedestrian lighting, billboard lighting and more. Available as a retrofit kit for sites with existing poles or purchase with pole kit, if needed.

REMOTELY SET UP YOUR NETWORK W/ SOLERA CONNECT Create one or more projects. Preset programming modes make programming lights and sensor settings quick and easy. Site grouping and custom control setup.

BI-DIRECTIONAL COMMUNICATION OVER A CELLULAR NETWORK Allows for remote monitoring and control of the solar collection, battery state, and lighting parameters. Each light included in a project is individually accessible. Get status updates to be alerted to unexpected conditions.



IMPROVE PEDESTRIAN SAFETY...



← SL-SBL-2W

OFF-GRID BOLLARD LIGHT

PART #	COMPARES TO	LUMENS	CCT	DIMENSIONS	LISTINGS
SL-SBL-2W-27K-BK-G1	30W HALOGEN	266	2700K	8.0" x 30.0"	CE FC
SL-SBL-2W-40K-BK-G1			4000K		

OPERATING MODE

☀️ DUSK TO DAWN

THREE UNIQUE MODELS, PERFECT FOR PATHWAYS, PIERS AND MORE...



SL-SPT-20W ↑

OFF-GRID POST TOP LIGHT

PART #	COMPARES TO	LUMENS	CCT	DIMENSIONS	EPA	LISTINGS
SL-SPT-20W-30K-SF-G2	150W HID	2000	3000K	16.0" x 32.0"	2.2	CE FC
SL-SPT-20W-40K-SF-G2			4000K			

OPERATING MODES

☀️ DUSK TO DAWN | ⌚ TIMER | 🚶 MOTION SENSING

SCAN FOR POLE OFFERINGS + ACCESSORIES



↑ SL-CPT

OFF-GRID PATHWAY LIGHT

PART #	COMPARES TO	LUMENS	CCT	DIMENSIONS	EPA	LISTINGS
SL-CPT-25L-30K-BK-G1	150W	2500	3000K	21.3" x 13.4"	1.0 SF	CE FC
SL-CPT-25L-40K-BK-G1			4000K			

OPERATING MODES

☀️ CONSTANT BRIGHTNESS | ⌚ TIMER | 🚶 MOTION SENSING

SCAN FOR POLE OFFERINGS + ACCESSORIES



- 3 YEAR WARRANTY
- 8-9 HRS BATTERY CHARGE TIME
- 32°F TO 149°F BATTERY CHARGING TEMP
- UP TO 18 HRS BATTERY LIFE
- 120° BEAM ANGLE
- 13°F TO 140°F OPERATING TEMP
- 100,000hrs RATED LIFE

- 3 YEAR WARRANTY
- 7-8 HRS BATTERY CHARGE TIME
- 32°F TO 149°F BATTERY CHARGING TEMP
- UP TO 30 HRS BATTERY LIFE
- 360° BEAM ANGLE
- 4°F TO 149°F OPERATING TEMP
- 100,000hrs RATED LIFE

- 3 YEAR WARRANTY
- 7-8 HRS BATTERY CHARGE TIME
- 32°F TO 122°F BATTERY CHARGING TEMP
- UP TO 30 HRS BATTERY LIFE*
- 160° BEAM ANGLE
- 4°F TO 122°F OPERATING TEMP
- 50,000hrs RATED LIFE

* ON 2HR + SENSOR MODE.



FLOOD + DISPLAY + MULTIFUNCTIONAL LIGHTS



...ADJUSTABLE – LIGHT EXACTLY WHERE YOU NEED IT



SL-SFL-20W

OFF-GRID FLOOD LIGHT

PART #	COMPARES TO	LUMENS	CCT	DIMENSIONS	ADJ HEIGHT	LISTINGS
SL-SFL-20W-40K-BK-G2	150W HID	2000	4000K	26.0" x 11.0" (PANEL w/ LIGHT)	16" TO 21"	CE FC

OPERATING MODE

☀️ CONSTANT BRIGHTNESS | ⌚ TIMER



SL-SDL-20W

OFF-GRID DISPLAY LIGHT

PART #	COMPARES TO	LUMENS	CCT	DIMENSIONS	LISTINGS
SL-SDL-2FT-40K-BK-G2	70W HID	750	4000K	23.6" x 4.3" x 4.3"	CE FC
SL-SDL-4FT-40K-BK-G2	150W HID	2000	4000K	47.2" x 4.3" x 4.3"	

ACCESSORIES

RP-SDL-BK-LB | 7" CLAMP MOUNT BRKT (2 PK)

OPERATING MODES

☀️ CONSTANT BRIGHTNESS | ⌚ TIMER

SURFACE MOUNT BRACKET INCLUDED

- 3 YEAR WARRANTY
- 8-9 HRS BATTERY CHARGE TIME
- 32°F TO 115°F BATTERY CHARGING TEMP
- UP TO 24 HRS BATTERY LIFE
- 120° BEAM ANGLE
- 4°F TO 140°F OPERATING TEMP
- 50,000hrs RATED LIFE

- 3 YEAR WARRANTY
- 8-9 HRS BATTERY CHARGE TIME
- 32°F TO 113°F BATTERY CHARGING TEMP
- UP TO 24 HRS BATTERY LIFE
- 120° BEAM ANGLE
- 4°F TO 140°F OPERATING TEMP
- 50,000hrs RATED LIFE

USE LIGHT ENGINE AS A POWER BANK...



SL-SMFL-10W

OFF-GRID MULTIFUNCTIONAL FLOOD LIGHT

PART #	COMPARES TO	LUMENS	CCT	DIMENSIONS	LISTINGS
SL-SMFL-10W-40K-BK-G1	70W HID	1100	4000K	9.1" x 6.5" (LIGHT) 13.6" x 9.3" (PANEL)	CE FC

OPERATING MODES

☀️ CONSTANT BRIGHTNESS | ⌚ TIMER | 🚶 MOTION SENSING

- 3 YEAR WARRANTY
- 8-9 HRS BATTERY CHARGE TIME
- 32°F TO 140°F BATTERY CHARGING TEMP
- UP TO 24 HRS BATTERY LIFE
- 90° BEAM ANGLE
- 4°F TO 140°F OPERATING TEMP
- 50,000hrs RATED LIFE



...ALL-IN-ONE DESIGN

MAKE IT MAGNETIC ↓

DETACHABLE SOLAR PANEL...

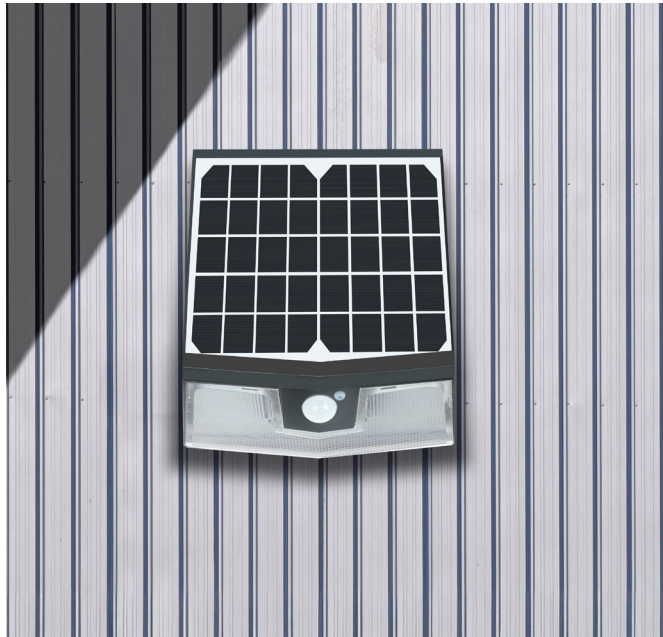

BUILT TO WITHSTAND EXTREME CLIMATES

SL-SWL-15W ↑

SL-SWL-16L ↑

OFF-GRID WALL PACK

PART #	COMPARES TO	LUMENS	CCT	DIMENSIONS	LISTINGS
SL-SWL-15W-40K-BK-G2	100W HID	1500	4000K	10.0" x 12.0" x 5.0"	CE FC
SL-SWL-15W-40K-BK-G2-M					

OPERATING MODES

 DUSK TO DAWN |  TIMER |  MOTION SENSING

OFF-GRID FLEXCOLOR WALL PACK

PART #	COMPARES TO	LUMENS	CCT	DIMENSIONS	LISTINGS
SL-SWL-16L-FC-BK-G3	100W HID	1600	FLEXCOLOR 3000K/4000K/5000K	13.0" X 12.0" X 5.0"	CE FC
SL-SWL-16L-FC-BK-G3-M					

OPERATING MODES

 CONSTANT BRIGHTNESS |  MOTION SENSING

-  3 YEAR WARRANTY
-  7 HRS BATTERY CHARGE TIME
-  32°F TO 149°F BATTERY CHARGING TEMP
-  UP TO 50 HRS BATTERY LIFE
-  100° BEAM ANGLE
-  5°F TO 113°F OPERATING TEMP
-  L70 35,000hrs RATED LIFE



↑

EACH MAGNET HOLDS UP TO 35 LBS. FOR A TOTAL PULL STRENGTH OF 140 LBS.

 MAGNETIC MOUNTING



--- DETACHABLE SOLAR PANEL

 MAGNETIC MOUNTING

-  3 YEAR WARRANTY
-  7 HRS BATTERY CHARGE TIME
-  -4°F TO 140°F BATTERY CHARGING TEMP
-  UP TO 25 HRS BATTERY LIFE
-  120° BEAM ANGLE
-  -40°F TO 140°F OPERATING TEMP
-  L70 50,000hrs RATED LIFE

R40 / R48
NON-NETWORKED
RFID CHARGING*
UP TO 48A
CHARGING POWER



P48 / P80
NETWORKED
SMART CHARGING
UP TO 48A
CHARGING POWER



S48
NON-NETWORKED
PLUG + CHARGE
UP TO 48A CHARGING POWER



P80d
DUAL PORT SMART
CHARGING
UP TO 80A
CHARGING POWER



D-SERIES
DC COMPACT
CHARGER / 40kW
PROVIDES UP TO
80 MILES OF RANGE IN
30 MINUTES

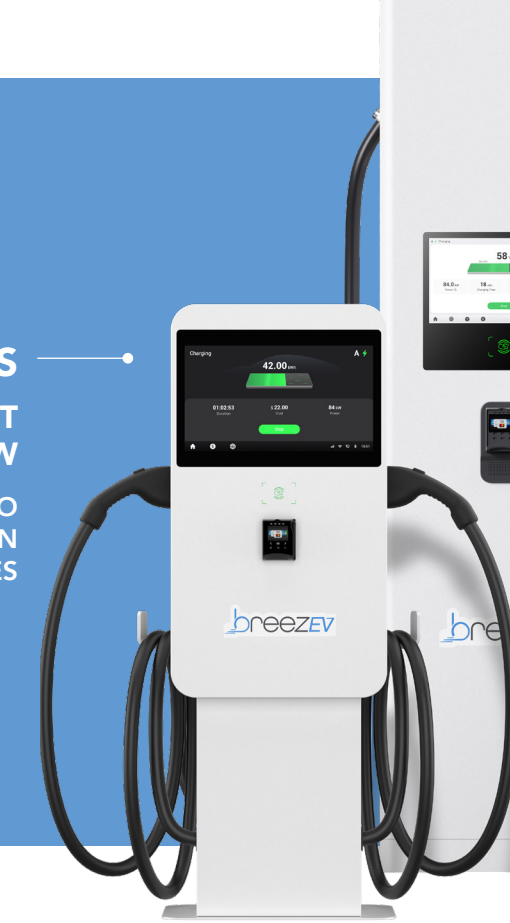

F-SERIES
DC HiPOWER CHARGER
480KW-640kW
PROVIDES UP TO 250 MILES
OF RANGE IN 10 MINUTES



C-SERIES
DC FAST CHARGER
60kW-240kW
PROVIDES UP TO
125 MILES OF RANGE IN
10 MINUTES



* 5 RFID CARDS INCLUDED.

LEVEL 2, NON-NETWORKED CHARGING

NO NETWORK NEEDED – SIMPLY PLUG + CHARGE



PART #	CHRG AMPS	CONNECTOR	NETWORK	USER INTERFACE	OCPP SOFTWARE	UNIT DIMENSIONS	LISTINGS
R40 ALL-IN-ONE KIT (INCLUDES CHARGER W/ 18 FT OR 25 FT, 10AWG, 40A CABLE)							
EVC-L2-R40-18	UP TO 40A	SAE J1772	RFID	N/A	N/A	9.8" x 14.2" x 3.9"	
EVC-L2-R40-25							
R48 ALL-IN-ONE KIT (INCLUDES CHARGER W/ 18 FT OR 25 FT, 8AWG, 48A CABLE)							
EVC-L2-R48-18	UP TO 48A	SAE J1772	RFID	N/A	N/A	9.8" x 14.2" x 3.9"	
EVC-L2-R48-25							
R40 / R48 IN THE BOX							
	18 FT (R40-18/R48-18) OR 25 FT (R40-25/R48-25) OUTPUT CORD W/ SAE J1772 CONNECTOR			5 RFID CARDS		MOUNTING HARDWARE + INSTRUCTIONS	

* 5 YEAR EXTENDED WARRANTY AVAILABLE. CONTACT SALES REPRESENTATIVE

PART #	CHRG AMPS	CONNECTOR	NETWORK	USER INTERFACE	OCPP SOFTWARE	UNIT DIMENSIONS	LISTINGS
S48 ALL-IN-ONE KIT (INCLUDES CHARGER W/ 18 FT OR 25 FT, 8AWG, 48A CABLE)							
EVC-L2-S48-18	UP TO 48A	SAE J1772	N/A	N/A	N/A	8" x 9.2" x 4"	
EVC-L2-S48-25							
S48 IN THE BOX							
	1 FT INPUT CORD W/ NEMA 14-50 PLUG (ATTACHED TO UNIT)			18 FT (S48-18) OR 25 FT (S48-25) OUTPUT CORD W/ SAE J1772 CONNECTOR			CABLE HOOK W/ HOLSTER + BACKPLATE
LEVEL 2 EV CHARGER TESTER							
	MOUNTING HARDWARE + INSTRUCTIONS						
PART #	DESCRIPTION						
EVC-L2-ACC-TESTER-J1772	VERIFY THE CORRECT OPERATION AND SETTING OF AN EV CHARGER AFTER INSTALLATION, W/O AN ELECTRIC VEHICLE PRESENT						

LEVEL 2, NETWORKED SMART CHARGING

PERFECT FOR
MULTI-UNIT HOUSING,
OR RETAIL PROPERTIES...



EQUIPPED W/ LCD SCREEN, RFID, OCPP NETWORK

INSTALL ON A
PEDESTAL OR
WALL MOUNT...



SCAN FOR MORE
INFO ON PEDESTALS +
MOUNTING OPTIONS



PART #	CHRG AMPS	CONNECTOR	CABLE LENGTH	NETWORK	USER INTERFACE	OCPP SOFTWARE	UNIT DIMENSIONS	LISTINGS
P48 ALL-IN-ONE KITS (INCLUDES CHARGER W/ 48A CABLE SET)								
EVC-L2-48A-L1-1-4G-D	UP TO 48A	SAE J1772	18FT	ETHERNET/RFID/4G	LCD DISPLAY	1YR AMPUP PRO	9.8" x 13.8" x 5.1"	
EVC-L2-48A-L1-1-4G-D-25			25FT					
P80 ALL-IN-ONE KIT (INCLUDES CHARGER W/ 80A CABLE SET)								
EVC-L2-P80-18-AP1	UP TO 80A	SAE J1772	18FT	ETHERNET/RFID/4G	LCD DISPLAY	1YR AMPUP PRO	9.8" x 13.8" x 5.1"	

PART #	DESCRIPTION	PART #	DESCRIPTION
PEDESTALS / ACCESSORIES			
EVC-L2-ACC-LPK2	LOWER PEDESTAL KIT FOR L2 CHARGER	EVC-L2-ACC-CM	CABLE MGMT FOR PEDESTAL W/ 2 RETRACTORS
EVC-L2-ACC-SSB	BRACKET FOR SIDE-BY-SIDE CHARGERS	EVC-L2-ACC-CM1	CABLE MGMT FOR PEDESTAL W/ 1 RETRACTOR
EVC-L2-ACC-ANCHOR KIT WET	WET CONCRETE ANCHOR KIT	EVC-L2-ACC-CMR	CABLE RETRACTOR W/ SPRING LOADED TETHER
EVC-L2-ACC-MAKE READY BASE	CHARGING STATION FOUNDATION	EVC-L2-ACC-HAD	HOOK/HOLSTER FOR WALL MOUNTING

LEVEL 2 EV CHARGER TESTER	
PART #	DESCRIPTION
EVC-L2-ACC-TESTER-J1772	VERIFY THE CORRECT OPERATION AND SETTING OF AN EV CHARGER AFTER INSTALLATION, W/O AN ELECTRIC VEHICLE PRESENT



LEVEL 2, NETWORKED SMART CHARGING



8-INCH HD
ADVERTISING
SCREEN...

UNIT W/ PEDESTAL
MOUNT SHOWN...

EQUIPPED W/ LCD SCREEN, RFID, OCPP NETWORK



PART #	MODEL #	DESCRIPTION
P80D		
BEV-L2-P80D-18-CM-P	MU38FP5C	DUAL 80A CHARGER, 18' 80A CABLE SET, 4G CELLULAR, POS, PEDESTAL MOUNT, CABLE MANAGMENT
BEV-L2-P80D-18	UF38C001	DUAL 80A CHARGER, 18' 80A CABLE SET, 4G CELLULAR, WALL-MOUNT
BEV-L2-P80D-25-CM-P	MU38FP7C	DUAL 80A CHARGER, 25' 80A CABLE SET, 4G CELLULAR, POS, PEDESTAL MOUNT, CABLE MANAGMENT
BEV-L2-P80D-25	UF38L001	DUAL 80A CHARGER, 25' 80A CABLE SET, 4G CELLULAR, WALL-MOUNT

PART #	MODEL #	DESCRIPTION
ACCESSORIES		
BEV-L2-P80D-PP	FPP	P80 PEDESTAL POST
BEV-L2-P80D-CM6	CMSB2	D80P-18 6' CABLE MANAGEMENT SYSTEM
BEV-L2-P80D-CM9	CMSA2	D80P-25 9' CABLE MANAGEMENT SYSTEM
BEV-L2-P80D-POS	POSA	D80P POS TERMINAL

LEVEL 3, NETWORKED SMART CHARGING



...INSTALL ON A PEDESTAL OR MOVABLE TROLLEY

...FOR PEOPLE & BUSINESSES WHERE TIME IS THE MOST VALUED ASSET



...PERFECT FOR HIGHWAY REST-STOP, GAS STATIONS AND FLEET MANAGEMENT

PART #	MODEL #	DESCRIPTION
C-SERIES DC COMPACT CHARGER		
BEV-L3-C40-25-PM	DC40APN25	DUAL 40KW COMPACT DCFC 25 FT PEDESTAL MOUNT CABLE/CCS1
BEV-L3-C40-25-PPM	DC40APC25	DUAL 40KW COMPACT DCFC 25 FT PEDESTAL MOUNT CABLE/CCS1 W/ POS
BEV-L3-C40-25-T	DC40ATN25	DUAL 40KW COMPACT DCFC 25 FT TROLLEY CABLE/CCS1

PART #	MODEL #	DESCRIPTION
D-SERIES DC FAST CHARGER		
BEV-L3-D60	UF060A3001	60KW UL DUAL PORT DCFC
BEV-L3-D120	UF120A3001	120KW UL DUAL PORT DCFC
BEV-L3-D180L	UF180A4001	180KW UL DUAL PORT DCFC
BEV-L3-D240L	UF240A4001	240KW UL DUAL PORT DCFC

PART #	MODEL #	DESCRIPTION
F-SERIES DC HI-POWER CHARGER		
BEV-L3-F480-2B	US480A2L0	480KW DCFC, 2 DISPENSERS 4 PORTS: BOOST 16' CABLE/CCS1 CABLE MANAGEMENT
BEV-L3-F480-2LC	US480A0L2	480KW DCFC, 2 DISPENSERS 4 PORTS: LIQUID COOLED 16' CABLE/CCS1 CABLE MANAGEMENT
BEV-L3-F640-2B	US640A2L0	640KW DCFC, 2 DISPENSERS 4 PORTS: BOOST 16' CABLE/CCS1 CABLE MANAGEMENT
BEV-L3-F640-2LC	US640A0L2	640KW DCFC, 2 DISPENSERS 4 PORTS: LIQUID COOLED 16' CABLE/CCS1 CABLE MANAGEMENT

INCLUDES...
2 POWER DISPENSERS
AND A NONDESCRIP
POWER CABINET.



CORPORATE HQ & TRAINING CENTER • CARY, IL | INNOVATION & MANUFACTURING CENTER • Middleton, MA
847.380.3540 • led-llc.com • sales@led-llc.com