

TOTALTUBE® T8 G3 INSTALLATION AND USER'S GUIDE

- PRO
- BASE
- SUPPLY
- CUSTOM

IMPORTANT SAFETY INSTRUCTIONS | READ AND FOLLOW ALL INSTRUCTIONS | SAVE THESE INSTRUCTIONS

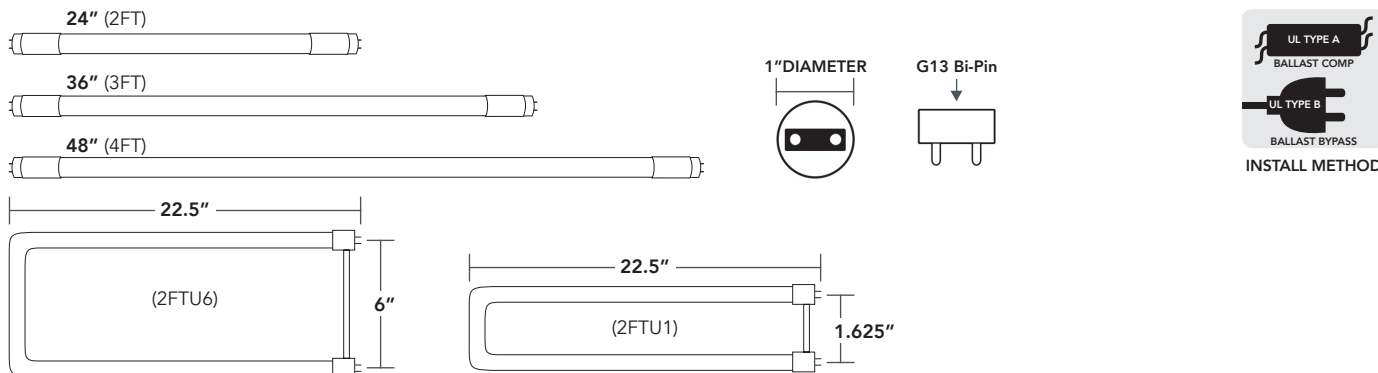

1. CHECK THE BALLAST INSTALLED IN THE FIELD AND MAKE SURE THE BALLAST IS LISTED ON MANUFACTURER'S BALLAST COMPATIBILITY LIST.
DO NOT INSTALL NEW LED LAMPS IF THE BALLAST IS NOT LISTED, PLEASE CONTACT US FIRST.
2. CHECK FOR LOOSE AND/OR DAMAGED LAMP-HOLDERS/SOCKETS. ADJUST OR REPLACE AS NECESSARY.
DO NOT INSTALL NEW LED LAMPS WITH ANY LOOSE AND/OR DAMAGED SOCKETS.
3. PAY ATTENTION TO THE MINIMUM TUBE REQUIREMENT AS FOLLOWS
 - WHEN USING THREE TUBE FLUORESCENT BALLAST FIXTURES, AT LEAST TWO TOTALTUBES MUST BE INSTALLED.
 - WHEN USING FOUR TUBE FLUORESCENT BALLAST FIXTURES, AT LEAST THREE TOTALTUBES MUST BE INSTALLED.

INSTALLATION WITH BALLAST IN-PLACE: ALWAYS DISABLE ELECTRICAL CIRCUIT BEFORE BEGINNING.

STEP 1 - TURN OFF THE POWER TO THE FIXTURE AT THE BREAKER PANEL BEFORE INSTALLATION.

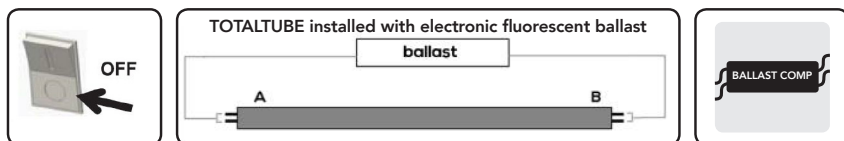

STEP 2 - OPEN OR REMOVE THE DIFFUSER/LENS/LOUVER FROM THE LIGHT FIXTURE.

STEP 3 - REMOVE THE FLUORESCENT LAMPS. PLEASE DISPOSE OF THESE ITEMS PROPERLY AS THEY MAY CONTAIN MERCURY.

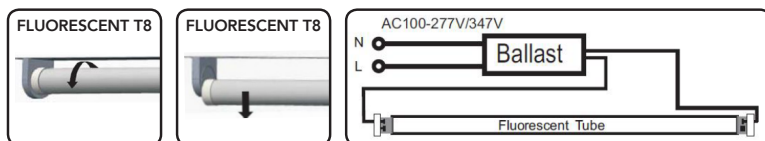

STEP 4 - INSTALL LED LAMPS INTO THE LIGHTING FIXTURE. ENSURE ALL PINS ARE FIRMLY SEATED IN LAMP-HOLDERS.

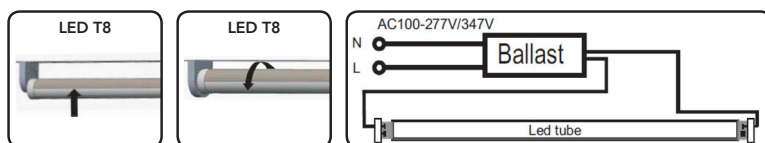

12.17 Information is subject to change without notice.

STEP 5 - REPLACE THE DIFFUSER/LENS/LOUVER FROM THE LIGHT FIXTURE.

STEP 6 - RESTORE POWER TO THE FIXTURE.



INSTALLATION WITHOUT BALLAST: ALWAYS DISABLE ELECTRICAL CIRCUIT BEFORE BEGINNING.

STEP 1 - TURN OFF THE POWER TO THE FIXTURE AT THE BREAKER PANEL BEFORE INSTALLATION.

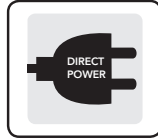
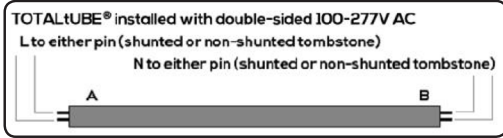
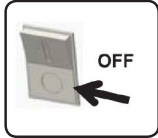

STEP 2 - OPEN OR REMOVE THE DIFFUSER/LENS/LOUVER FROM THE LIGHT FIXTURE.

STEP 3 - REMOVE THE FLUORESCENT LAMPS. PLEASE DISPOSE OF THESE ITEMS PROPERLY AS THEY MAY CONTAIN MERCURY.

STEP 4 - REMOVE THE EXISTING BALLAST OR BYPASS THE BALLAST BY CUTTING THE WIRES AND CAPPING THEM.

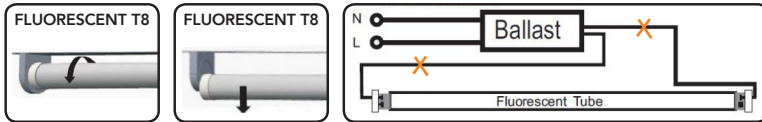

STEP 5 - INSTALL LED LAMPS INTO THE LIGHTING FIXTURE. **ENSURE ALL PINS ARE FIRMLY SEATED IN LAMP-HOLDERS.**

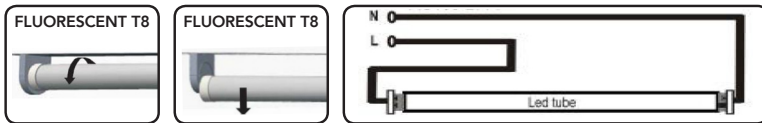

STEP 6 - REPLACE THE DIFFUSER/LENS/LOUVER FROM THE LIGHT FIXTURE.

STEP 7 - RESTORE POWER TO THE FIXTURE.



WARNING

1. RISK OF FIRE AND ELECTRIC SHOCK.
2. THESE LAMPS ARE TO BE USED IN INDOOR, AND SUITABLE FOR USE IN DAMP LOCATIONS.
3. THESE LAMPS CAN WORK WITH MANY EXISTING INSTANT-START BALLAST AS LISTED ON MANUFACTURER'S BALLAST COMPATIBILITY LIST. CHECK THIS LIST FIRST.
4. IF THE NEW LED LAMP OR LUMINAIRE EXHIBITS ABNORMAL OR UNDESIRABLE OPERATION (BUZZING, FLICKERING, ETC.), IMMEDIATELY TURN OFF POWER, REMOVE LED LAMP FROM LUMINAIRE AND CONTACT MANUFACTURER.

PLEASE NOTE: When installing an LED tube with an existing or new fluorescent ballast, always confirm that: (1) the ballast is compatible with the LED tube by checking the ballast compatibility guide (2) the lamp holders utilized and the wiring diagram are correct for that specific fluorescent ballast, by checking the fluorescent ballast installation guide (for example, DO NOT use non-shunted sockets on instant-start ballasts (3) the lamp holders are in good working condition and are making contact with all of the LED tube pins (for example, DO NOT install an LED tube in a loose lamp holder where there is a visible air gap between the end of the LED tube and the lamp holder) so that there is no risk of arcing.

12.17 Information is subject to change without notice.