



IMPORTANT

READ CAREFULLY BEFORE INSTALLING FIXTURE.
RETAIN THESE INSTRUCTIONS FOR FUTURE REFERENCE.

INSTALLATION INSTRUCTIONS — PLEASE COMPLY WITH THESE INSTRUCTIONS AND NOTES TO ENSURE THAT THE PRODUCT IS OPERATED IN A SAFE CONDITION

SAFETY PRECAUTIONS — FOR YOUR AND OTHERS' SAFETY, PLEASE READ THE PRECAUTION CAREFULLY BEFORE INSTALLATION









WARNING

CAUTION - RISK OF FIRE. TURN OFF POWER BEFORE INSTALLATION.
CAUTION - RISK OF SHOCK. INSTALL ONLY BY A CERTIFIED ELECTRICIAN WEARING GLOVES. SUITABLE FOR DAMP LOCATIONS.
CONSULT A QUALIFIED ELECTRICIAN TO ENSURE CORRECT BRANCH CIRCUIT CONDUCTOR. THIS PRODUCT MUST BE INSTALLED IN ACCORDANCE WITH THE APPLICABLE INSTALLATION CODE BY A PERSON FAMILIAR WITH THE CONSTRUCTION AND OPERATION OF THE PRODUCT AND THE HAZARDS INVOLVED.
If the luminaire exhibits undesirable operation (buzzing, flickering, not working, etc.), immediately turn off power, remove the luminaire, and contact the manufacturer.
Do not make a mass installation before testing.

AVERTISSEMENT

ATTENTION - RISQUE D'INCENDIE. COUPEZ L'ALIMENTATION AVANT L'INSTALLATION.
ATTENTION - RISQUE DE CHOC ÉLECTRIQUE. Faites installer uniquement par un électricien certifié portant des gants.
CONVIENT AUX EMPLACEMENTS MOUILLES.
CONSULTER UN ELECTRICIEN QUALIFIE POUR VOUS ASSURER QUE LES CONDUCTEURS DE LA DERIVATION SONT ADEQUATS.
CE PRODUIT DOIT ÊTRE INSTALLÉ SELON LE CODE D'INSTALLATION PERTINENT, PAR UNE PERSONNE QUI CONNAÎT BIEN LE PRODUIT ET SON FONCTIONNEMENT, AINSI QUE LES RISQUES INHÉRENTS.
Si le luminaire présente un fonctionnement indésirable (bourdonnement, scintillement, ne fonctionne pas, etc.), coupez immédiatement l'alimentation, retirez le luminaire et contactez le fabricant.
Ne procédez pas à une installation en série avant d'avoir effectué un.

WHAT IS IN THE ACCESSORY BAG

M4*25	M4*25	Self-Tapping Screw	NUT	M4 NUT	Wago Connector	SCREW-DRIVER	GOSSIP BOARD	SAFETY ROPE
								
2PCS	2PCS	2PCS	2PCS	2PCS	4PCS	1PCS	1PCS	1PCS



SENSOR READY

OPTIONAL NETWORK LIGHTING CONTROL

OPTIONAL SIMPLE OCC

OPTIONAL EMG BATTERY BACKUP

BEAM ANGLE

CRI

OPERATING TEMP

100,000hrs RATED LIFE

HEADQUARTERS & TRAINING CENTER • Cary, IL | INNOVATION & MANUFACTURING CENTER • Middleton, MA

847.380.3540 • led-llc.com • sales@led-llc.com

05.05.26 Information is subject to change without notice.

Light Efficient Design.



PRIOR TO INSTALLATION, PLEASE READ THE ENTIRE INSTALLATION INSTRUCTIONS

INSTALLATION

1. Disconnect or turn off power before installation. See diagram 1

2. Thread the screws into the mounting plate. See diagram 2

3. Secure the mounting plate firmly to the ceiling junction box using a screwdriver. See diagram 3

4. Remove lens by unscrewing the decorative nuts. Tilt the cover to remove it from the fixture base. See diagram 4

5. Use the lever nuts to hardwire to the mains power. See diagram 5.

6. Once the wiring is secured, mount the fixture body to the plate and tighten the screws to hold it in place. See diagram 6

7. Reinstall the lamp cover. Tilt the cover back into position and tighten the decorative nuts to secure it. See diagram 7

8. Reconnect the power and the light will turn on. See diagram 8

NOTE:

1. if applicable, adjust the FLEXWATT and/or FLEXCOLOR switches to the desired wattage and CCT. Not all models have these adjustments. To adjust settings, use the small screwdriver supplied to adjust the switches to the desired wattage and CCT settings.
2. Check your model and product specification sheet for more details.
3. Make all necessary wiring connections, observing proper voltage and polarity before installation.
4. WARNING - To prevent wiring damage or abrasion, do not expose wiring to edges of sheet metal or other sharp objects.

IF THE PRODUCT HAS AN EMERGENCY DRIVER, PLEASE REFER TO THE WIRING DIAGRAM BELOW INSTEAD OF STEP 5

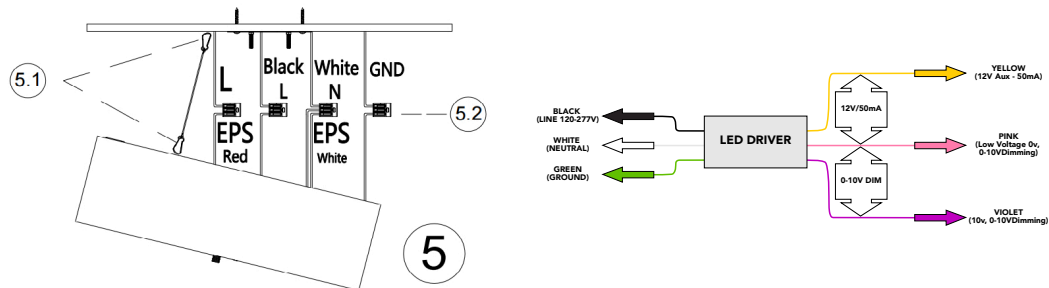

PART #	DESCRIPTION	WATTAGE	LUMENS	LPW	CCT
RP-DAL-18N-14L-40K-WC-G2	18" LINEN DRUM	FLEXWATT	600-2200	110	FLEXCOLOR 3000K/3500K/ 4000K
RP-DAL-18N-14L-40K-WC-G2-4S	18" LINEN DRUM W/ SPOKES	6W/ 10W /16W/22W			

DEFAULT WATTAGE AND CCT ARE SHOWN IN BOLD.



OPTIONAL EMERGENCY BATTERY BACKUP KIT

URNS ON WHEN POWER GOES OFF



90 MIN RUN TIME

41°F TO 131°F
OPERATING TEMP

OPTIONAL EMG
BATTERY BACKUP

EMG DRIVER DIMENSIONS

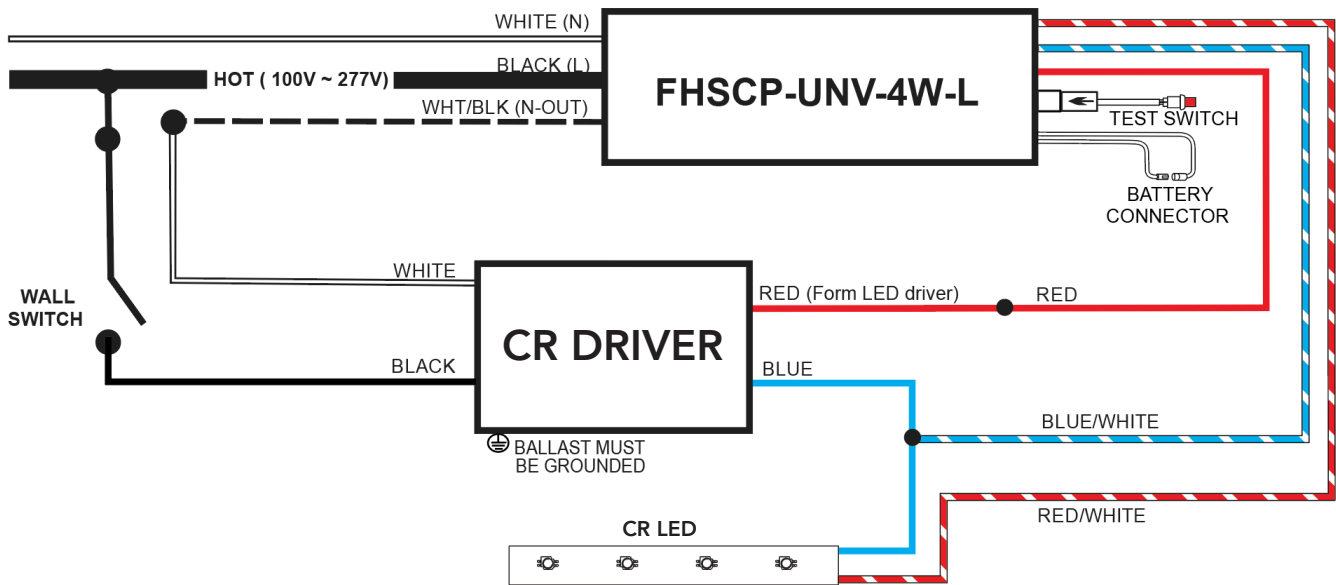



OPTIONAL EMERGENCY BATTERY BACKUP KIT

PRODUCT SPEC	INFORMATION
INPUT VOLTAGE / FREQUENCY	120-277V~ , 50/60Hz
INPUT CURRENT	100mA Max
INPUT POWER	3W
STANDBY POWER	<0.85W
DRIVER TYPE	Constant Power
CURRENT RATED	333mA@12V, 73mA@55V
OUTPUT VOLTAGE RANGE	12-55V
OUTPUT POWER	4W
OUTPUT CLASS	LED Class 2
NUMBER OF OUTPUT CHANNELS	1
TEST SWITCH	Included
PILOT LIGHT	Red Light
BATTERY ON/OFF	Wire + Connector
LOCATION TYPE	Dry Location
INPUT SURGE PROTECTION	Line-Neutral 1kV, Line & Neutral-Ground 2kV
EMERGENCY MODE PROTECTIONS	Battery Over Voltage Protection Battery Under Voltage Protection Battery Hot Plug at Normal Mode Protection Battery Hot Plug at Emergency Mode Protection
RFI/EMI	FCC Part 15 Class A
AMBIENT OPERATING TEMPERATURE RANGE	5°C To 55°C(41°F To 131°F)
BATTERY TYPE	LiFePO4
BATTERY VOLTAGE	6.4V
BATTERY CAPACITY	2Ah Max
BATTERY CHARGE CURRENT	165mA
BATTERY RECHARGE TIME	12 Hours
BATTERY DISCHARGE TIME	Minimum 90 Minutes
SERVICE LIFE	50,000 Hours
WARRANTY	5 Years